

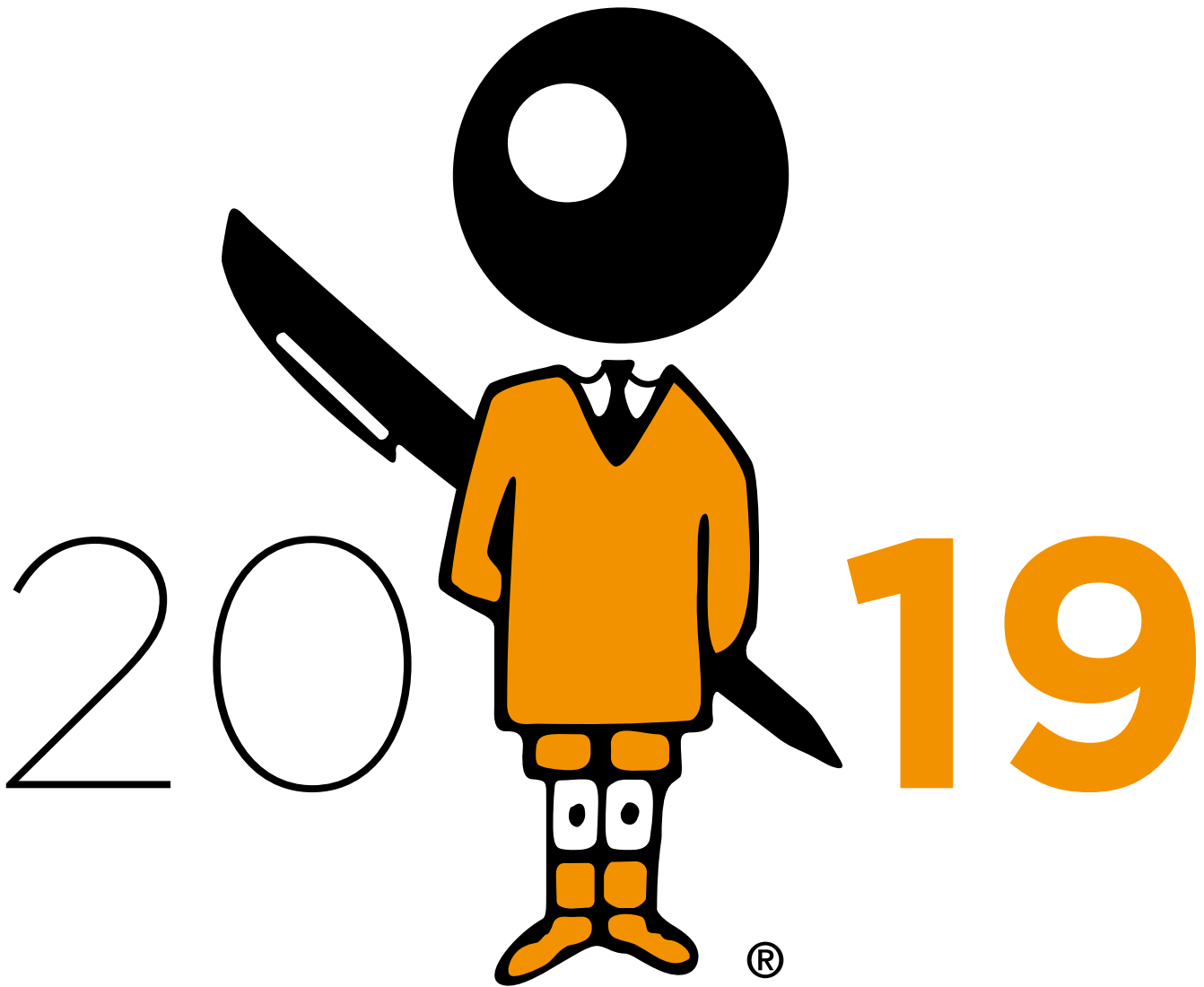

Your Brand Ambassador



WHAT'S BETTER THAN A REAL BRAND
TO PROMOTE YOURS?

> WRITING INSTRUMENTS > STICKY NOTES > NOTEBOOKS > OFFICE ACCESSORIES > LIGHTERS&CASES > SHAVERS > BAGS > TECHNOLOGY > PACKAGING





 *Metallic Pens*

BIC® offers an exclusive selection of upscale writing instruments ideal for your corporate gift or recognition program.

FR > BIC® propose une sélection exclusive d'instruments d'écriture, idéale pour vos cadeaux d'affaire ou vos programmes de récompense.

DE > BIC® bietet eine exklusive Auswahl an gehobenen Schreibgeräten. Ideal als Werbegeschenk oder für Ihr Anerkennungsprogramm.

ES > BIC® ofrece una exclusiva selección de instrumentos de escritura de alta calidad ideal para tu programa de reconocimiento o regalo corporativo

IT > BIC® offre un'esclusiva selezione di pregiati strumenti di scrittura, ideali come regalo aziendale o per un programma di riconoscimento.





1840



Iconic BIC® Boy is embossed



50

Colour ink
Encre de couleur
Color de la tinta
Schreibfarbe
Colore inchiostro

02



MOA 50v.

Decoration:

Personalisation / Personalización / Dekoration / Decorazione

BIC® Attriant®
1840

A LE: right & left clip

B SP: max. 1 col.

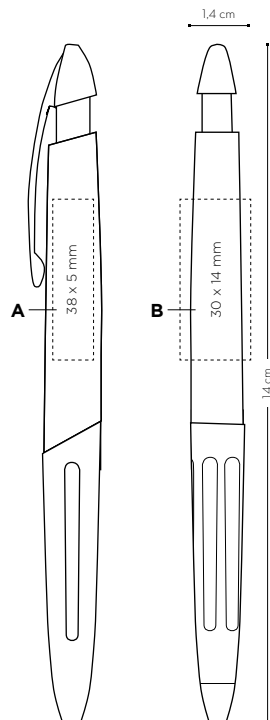

Price (CHF)

BIC® Attriant®	50-91	100-241	250-491	500-991	1000-2491	2500-4991	5000-9991
1840							
SP	8,38	7,81	7,23	6,76	6,34	①	①
LE	9,71	8,90	8,25	7,69	7,20	①	①

ADDITIONAL IMPRINT CHARGE PER COLOUR & POSITION frais d'impression supplémentaires par couleur et position / cargo por impresión adicional por color y posición / zusätzliche druckkosten pro farbe & position / costo marchio aggiuntivo per colore e posizione

LE	1,82	1,55	1,41	1,28	1,10	①	①
-----------	------	------	------	------	------	---	---

Prices include one imprint in one position according to specified technique. Les prix incluent une impression sur un emplacement avec la technique spécifiée / Los precios incluyen una impresión en una posición acorde con la técnica especificada / In den Preisen inbegriffen ist ein Aufdruck auf einer Position gemäß angegebener Technik / I prezzi includono una stampa in una posizione a seconda della tecnica specificata.

① Price under request. Prix sur demande. Precio bajo consulta. Preis auf Anfrage. Prezzi su richiesta.

Writing modes:

Mode écriture / Modos de escritura / Schreibmodi / Modalità di scrittura

Ballpen



M

*48h only available in LE *48h uniquement disponible en LE / *48h solo disponible en LE / *48h Nur für Lasergravur / *48 h disponibile solo in LE

Packaging:

embalaje / envasado / verpackung / imballaggio



Standard Packaging:
Black velvet pouch
for 1 item

Printing techniques:

Techniques d'impression / Técnicas de impresión / Drucktechniken / Tecniche di stampa



(SP) SCREEN
PRINTING



(LE) LASER

External packaging:

Emballage externe / Envasado exterior / Außenverpackung / Imballaggio esterno



150 ± 4,65 Kg

BIC® Protrusion Grip



1836



Iconic BIC® Boy is embossed



47

Colour ink
Encre de couleur
Color de la tinta
Schreibfarbe
Colore inchiostro



02



MOQ 500.

Decoration:

Personnalisation / Personalización /
Dekoration / Decorazione

BIC® Protrusion Grip

1836

A LE: right & left clip

B SP: max. 1 col.

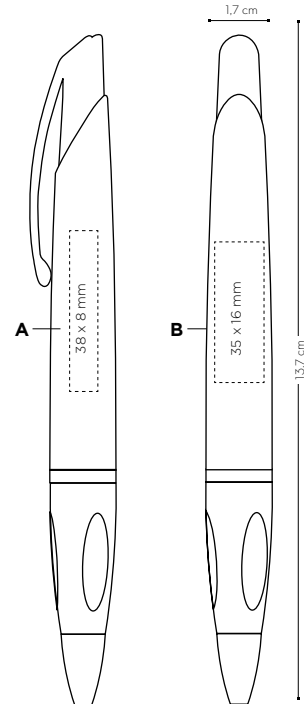

Price (CHF)

BIC® Protrusion Grip

50-99

100-249

250-499

500-999

1000-2499

2500-4999

5000-9999

1836

SP

8,03

7,46

6,91

6,46

6,05

①

①

LE

9,35

8,56

7,92

7,39

6,91

①

①

ADDITIONAL IMPRINT CHARGE PER COLOUR & POSITION frais d'impression supplémentaires par couleur et position / cargo por impresión adicional por color y posición / zusätzliche druckkosten pro farbe & position / costo marchio aggiuntivo per colore e posizione

LE

1,82

1,55

1,41

1,28

1,10

①

①

Prices include one imprint in one position according to specified technique. Les prix incluent une impression sur un emplacement avec la technique spécifiée / Los precios incluyen una impresión en una posición acorde con la técnica especificada / In den Preisen inbegriffen ist ein Aufdruck auf einer Position gemäß angegebener Technik / I prezzi includono una stampa in una posizione a seconda della tecnica specificata.

① Price under request. Prix sur demande. Precio bajo consulta. Preis auf Anfrage. Prezzi su richiesta.

Writing modes:

Mode écriture / Modos de escritura /
Schreibmodi / Modalità di scrittura

Ballpen



M

*48h only available in LE / 48h uniquement disponible en LE / *48h solo disponible en LE / *48h Nur für Lasergravur / *48h disponibile solo in LE

Packaging:

emballage / envasado /
verpackung / imballaggio



Standard Packaging:
Black velvet pouch
for 1 item

Printing techniques:

Techniques d'impression / Técnicas de impresión /
Drucktechniken / Tecniche di stampa



(SP) SCREEN
PRINTING



(LE) LASER

External packaging:

Emballage externe / Envasado exterior /
Außenverpackung / Imballaggio esterno



150 ± 4,65 Kg

Wide Body™ Metal



1285



02



07



100%

Iconic BIC® Boy
is embossed

Colour ink
Encre de couleur
Color de la tinta
Schreibfarbe
Colore inchiostro



47



BIC® WRITING INSTRUMENTS

METALLIC PENS

*48h only available in LE / *48h uniquement disponible en LE / *48h solo disponible en LE / *48h Nur für Lasergravur / *48 h disponibile solo in LE



MOQ 50v.

Decoration:

Personnalisation / Personalización / Dekoration / Decorazione

BIC® Wide Body Metal™

1285

A/B LE

C LE: right, left & rear clip

D/E/F SP: max. 1 col.

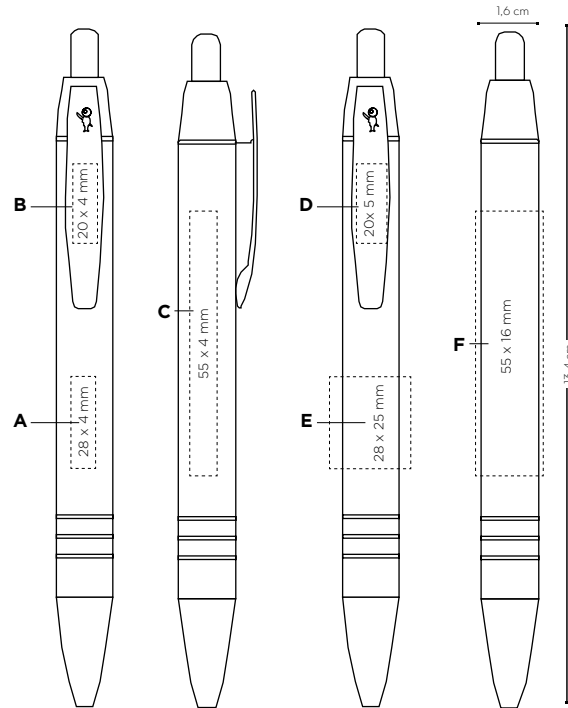

	Price (CHF)						
BIC® Wide Body Metal™	50-99	100-249	250-499	500-999	1000-2499	2500-4999	5000-9999
1285							
SP	6,24	5,81	5,37	5,03	4,68	①	①
LE	7,57	6,90	6,38	5,96	5,54	①	①

ADDITIONAL IMPRINT CHARGE PER COLOUR & POSITION frais d'impression supplémentaires par couleur et position / cargo por impresión adicional por color y posición / zusätzliche druckkosten pro farbe & position / costo marchio aggiuntivo per colore e posizione

SP	0,49	0,46	0,40	0,35	0,24	①	①
LE	1,82	1,55	1,41	1,28	1,10	①	①

Prices include one imprint in one position according to specified technique. Les prix incluent une impression sur un emplacement avec la technique spécifiée / Los precios incluyen una impresión en una posición acorde con la técnica especificada / In den Preisen inbegriffen ist ein Aufdruck auf einer Position gemäß angegebener Technik / I prezzi includono una stampa in una posizione a seconda della tecnica specificata.

① Price under request. Prix sur demande. Precio bajo consulta. Preis auf Anfrage. Prezzi su richiesta.

Writing modes:

Mode écriture / Modos de escritura / Schreibmodi / Modalità di scrittura

Ballpen



M

Packaging:

emballage / envasado / verpackung / imballaggio



Standard Packaging:
Black velvet pouch
for 1 item

Printing techniques:

Techniques d'impression / Técnicas de impresión / Drucktechniken / Tecniche di stampa



(SP) SCREEN
PRINTING



(LE) LASER

External packaging:

Emballage externe / Envasado exterior / Außenverpackung / Imballaggio esterno



150 ± 4 Kg

Tri-Tone Twist



BIC® WRITING INSTRUMENTS

METALLIC PENS

1943



08



25

100%



02

Iconic BIC® Boy
is embossed

Colour ink
Encre de couleur
Color de la tinta
Schreibfarbe
Colore inchiostro

*48h only available in LE / *48h uniquement disponible en LE / *48h solo disponible en LE / *48h Nur für Lasergravur / *48 h disponibile solo in LE



MOQ 500.

Decoration:

Personnalisation / Personalización / Dekoration / Decorazione

BIC® TRI-TONE TWIST

1943

A LE: right, left & rear clip

B LE: right, left, rear
& clip centred **

C SP: max. 1 col.

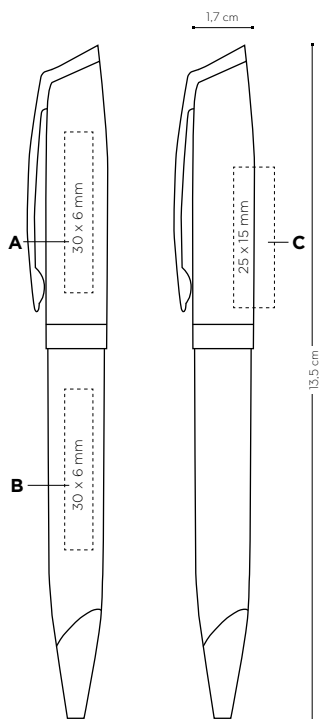

Price (CHF)

BIC® TRI-TONE TWIST	50-99	100-249	250-499	500-999	1000-2499	2500-4999	5000-9999
1943							
SP	9.27	8.63	7.99	7.49	7.02	①	①
LE	10.59	9.72	9.00	8.42	7.88	①	①

ADDITIONAL IMPRINT CHARGE PER COLOUR & POSITION frais d'impression supplémentaires par couleur et position / cargo por impresión adicional por color y posición / zusätzliche druckkosten pro farbe & position / costo marchio aggiuntivo per colore e posizione

LE	1.82	1.55	1.41	1.28	1.10	①	①
-----------	------	------	------	------	------	---	---

Prices include one imprint in one position according to specified technique. Les prix incluent une impression sur un emplacement avec la technique spécifiée / Los precios incluyen una impresión en una posición acorde con la técnica especificada / In den Preisen inbegriffen ist ein Aufdruck auf einer Position gemäß angegebener Technik / I prezzi includono una stampa in una posizione a seconda della tecnica specificata.

① Price under request. Prix sur demande. Precio bajo consulta. Preis auf Anfrage. Prezzi su richiesta.

Writing modes:

Mode écriture / Modos de escritura / Schreibmodi / Modalità di scrittura

Ballpen



M

LE not available on blue barrel
LE non disponibile sur corps bleu
LE no disponible en cuerpo azul
Lasergravur auf blauem Schaft ausgeschlossen
LE non disponibile su fusto blu

Packaging:

emballage / envasado / verpackung / imballaggio



Standard Packaging:
Black velvet pouch
for 1 item

Printing techniques:

Techniques d'impression / Técnicas de impresión / Drucktechniken / Tecniche di stampa



(SP) SCREEN
PRINTING



(LE) LASER

External packaging:

Emballage externe / Envasado exterior / Außenverpackung / Imballaggio esterno



150 ± 4,65 Kg

Gel-ocity® Illusion

BIC® Gel-ocity® Illusion® gel pen is an erasable gel stic pen.
Write, erase and rewrite repeatedly!



FR > Le stylo BIC® Gel-ocity® Illusion® est un stylo à encre gel effaçable. Écrivez, effacez et réécrivez encore !

DE > BIC® Gel-ocity® Illusion® gel ist ein ausradierbarer Gel-Kugelschreiber. Schreiben, radieren, neu schreiben, immer wieder!

ES > El bolígrafo BIC® Gel-ocity Illusion® gel es un bolígrafo borrrable con tinta gel. ¡Escribe, borra y re-escribe repetidamente!

IT > La penna gel BIC® Gel-ocity Illusion® è uno strumento con inchiostro gel cancellabile. Scrivi, cancella e riscrivi quante volte vuoi!





ROLLERS & GEL
BIC® WRITING INSTRUMENTS



BIC® Gel-ocity® Illusion

New!



OPAQUE - 1136



03

Colour ink
Encre de couleur
Color de la tinta
Schreibfarbe
Colore inchiostro



05



04



02



Erasable ink using
thermosensitive technology:
write, erase and rewrite
repeatedly

FR > L'encre effaçable utilise la technologie thermosensible : écrivez, effacez et réécrivez encore.

ES > Tinta borrable usando una tecnología termosensitiva: Escribe, borra y re-escribe repetidamente

DE > Ausradierbare Tinte dank temperaturempfindlicher Technologie: schreiben, radieren, neu schreiben, immer wieder.

IT > Inchiostro cancellabile grazie alla tecnologia termosensibile: scrivi, cancella e riscrivi quante volte vuoi



Available only in:
EU (including Norway, Switzerland and Turkey)
Disponibile unicamente in: UE (incluando la Norvegia, la Svizzera e la Turchia) / Solo disponibile in: EU (incluyendo Noruega, Suiza y Turquía) / Verfügbar nur in: EU (inklusive Norwegen, Schweiz und Türkei) / Disponibile solo in: UE (compresa Norvegia, Svizzera e Turchia)



MOQ 2500.

Decoration:

Personnalisation / Personalización / Dekoration / Decorazione

BIC® Gel-ocity® Illusion

1136

A SP: max. 1 col.

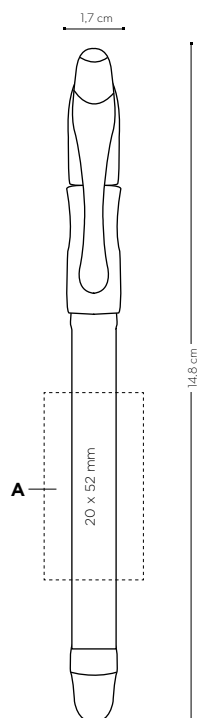

Price (CHF)

BIC® Gel-ocity® Illusion	250-499	500-999	1000-2499	2500-4999	5000-9999	10000-24999	25000-49999
1136							
SP	2,96	2,69	2,51	2,33	2,20	①	①

Prices include 1 colour screenprint in one position. Les prix incluent la sérigraphie 1 couleur sur un emplacement. En precio incluye un color en serigrafía en una posición. In den Preisen inbegriffen ist 1 Siebdruck-Farbaufdruck auf 1 Position. I prezzi includono 1 colore a serigrafia in una posizione.

① Price under request. Prix sur demande. Precio bajo consulta. Preis auf Anfrage. Prezzi su richiesta.

Writing modes:

Mode écriture / Modos de escritura / Schreibmodi / Modalità di scrittura

Gel erasable



GØ0,7mm

Printing techniques:

Techniques d'impression / Técnicas de impresión / Drucktechniken / Tecniche di stampa



(SP) SCREEN PRINTING

External packaging:

Emballage externe / Envasado exterior / Außenverpackung / Imballaggio esterno



500 ± 5,87 Kg



 Atlantis® Gel

So fluid that it writes as quickly as you think. Feel the comfortable writing with the BIC® Atlantis® Gel, dressed in a modern look with metal clip and chrome painted trim.

BIC® WRITING INSTRUMENTS

ROLLERS & GEL

FR > La famille de produits Atlantis® accueille une version encre gel ultra-douce à l'aspect moderne, dotée d'un clip métallique et d'attributs chromés.

DE > So fließend das er schneller schreibt als Sie denken. Fühlen Sie das komfortable Schreiben mit dem BIC® Atlantis® Gel, gekleidet im modernen Look mit Metallclip und chromfarbigen Verzierungen.

ES > Tan fluido que escribe más rápido de lo que piensas. Siente la cómoda escritura con el BIC® Atlantis Gel, de aspecto moderno con el clip metal y atributos pintados de color cromado.

IT > Così fluido che scrive più velocemente di quanto pensi. Goditi un'esperienza di scrittura confortevole con il BIC® Atlantis® Gel, dal look moderno con clip in metallo e finitura cromata.





1062



Iconic BIC® Boy is embossed

MOQ 250v.

Decoration:

Personnalisation / Personalización / Dekoration / Decorazione

BIC® Atlantis® Gel
1062

A PD: right, left
or rear clip max 1 col.

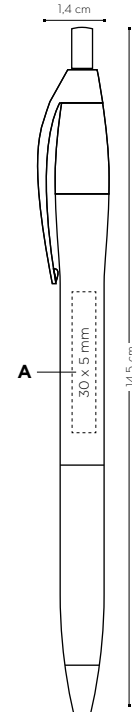

Colour ink
Encre de couleur
Color de la tinta
Schreibfarbe
Colore inchiostro

40



65

Price (CHF)

BIC® Atlantis® Gel	250-499	500-999	1000-2499	2500-4999	5000-9999	10000-24999	25000-49999
1062							
PD	1,77	1,60	1,48	1,38	1,30	①	①

ADDITIONAL IMPRINT CHARGE PER POSITION frais d'impression supplémentaires par position / cargo adicional por posición / zusätzliche druckkosten pro position / costo aggiuntivo di stampa per posizione

PD	0,18	0,15	0,15	0,15	0,14	①	①
----	------	------	------	------	------	---	---

Prices include 1 colour padprint in one position. Les prix incluent la tampographie monochrome sur un emplacement. Los precios incluyen una color en tampografía en una posición. In den Preisen inbegriffen ist ein Tampondruck-Aufdruck auf einer Position. I prezzi includono 1 colore con stampa a tampone in una posizione.

① Price under request. Prix sur demande. Precio bajo consulta. Preis auf Anfrage. Prezzi su richiesta.

Writing modes:

Mode écriture / Modos de escritura / Schreibmodi / Modalità di scrittura

Gel



GØ0,7mm

Printing techniques:

Techniques d'impression / Técnicas de impresión / Drucktechniken / Tecniche di stampa



(PD) PAD PRINTING

External packaging:

Emballage externe / Envasado exterior / Außenverpackung / Imballaggio esterno



250 ± 3 Kg

Grip Roller

Enjoy a smooth writing experience. Glide across the paper easily without smudging thanks to the quick-drying ink, ideal for both left and right-handed people.



FR > Profitez d'une expérience d'écriture fluide. Parfait pour les droitiers comme pour les gauchers, il glisse facilement sur le papier et ne fait pas de tâches grâce à son encre à séchage rapide.

ES > Disfruta de una experiencia de escritura suave. Se desliza fácilmente a través del papel y sin manchas gracias a la tinta de secado rápido, ideal tanto para las personas zurdas como diestras.

DE > Genießen Sie ein weiches Schreibgefühl. Gleiten Sie über das Papier ohne dass etwas verschmieren kann, dank der schnelltrocknenden Tinte - ideal für Links- und Rechtshänder.

IT > Goditi un'esperienza di scrittura morbidissima. Scorre facilmente sulla carta senza macchiare grazie all'inchiostro ad asciugatura immediata, ideale per mancini e destrorsi.



ROLLERS & GELS
BIC® WRITING INSTRUMENTS



BIC® Grip Roller



Iconic BIC® Boy is embossed



BIC® Grip Roller
1187

BIC® WRITING INSTRUMENTS
ROLLERS & GEL



Colour ink
Encre de couleur
Color de la tinta
Schreibfarbe
Colore inchiostro



BIC® Grip Roller Gold
1195



02/26

MOQ 250v.

Decoration:

Personnalisation / Personalización / Dekoration / Decorazione

BIC® Grip Roller

1195

1187 (gold)

A/B SP: max. 3 col.

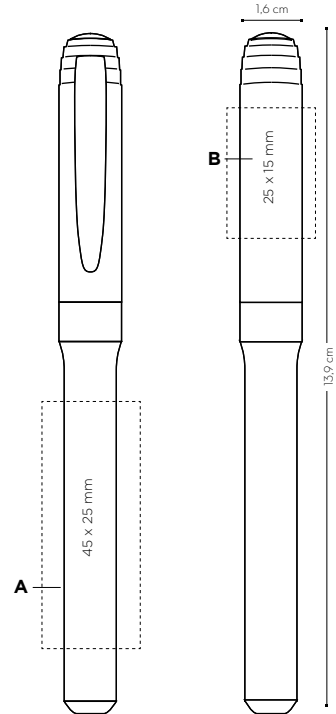

Price (CHF)

BIC® Grip Roller 1195/1187	250-499	500-999	1000-2499	2500-4999	5000-9999	10000-24999	25000-49999
SP	1,87	1,69	1,58	1,46	1,37	①	①

ADDITIONAL IMPRINT CHARGE PER COLOUR & POSITION frais d'impression supplémentaires par couleur et position / cargo por impresión adicional por color y posición / zusätzliche druckkosten pro farbe & position / costo marchio aggiuntivo per colore e posizione

SP	0,18	0,15	0,15	0,15	0,14	①	①
----	------	------	------	------	------	---	---

Prices include 1 colour padprint in one position. Les prix incluent la tampographie monochrome sur un emplacement. Los precios incluyen una color en tampografía en una posición. In den Preisen inbegriffen ist ein Tampondruck-Aufdruck auf einer Position. I prezzi includono 1 colore con stampa a tampone in una posizione.

① Price under request. Prix sur demande. Precio bajo consulta. Preis auf Anfrage. Prezzi su richiesta.

Writing modes:

Mode écriture / Modos de escritura / Schreibmodi / Modalità di scrittura

Roller



RØ0,7mm

Printing techniques:

Techniques d'impression / Técnicas de impresión / Drucktechniken / Tecniche di stampa



(SP) SCREEN PRINTING

External packaging:

Emballage externe / Envasado exterior / Außenverpackung / Imballaggio esterno



250 ± 3 Kg



Intensity® Gel Clic

Stylish ultra-smooth gel pen available in blue and black ink.
Automatic retracting mechanism to avoid stains on the pockets.

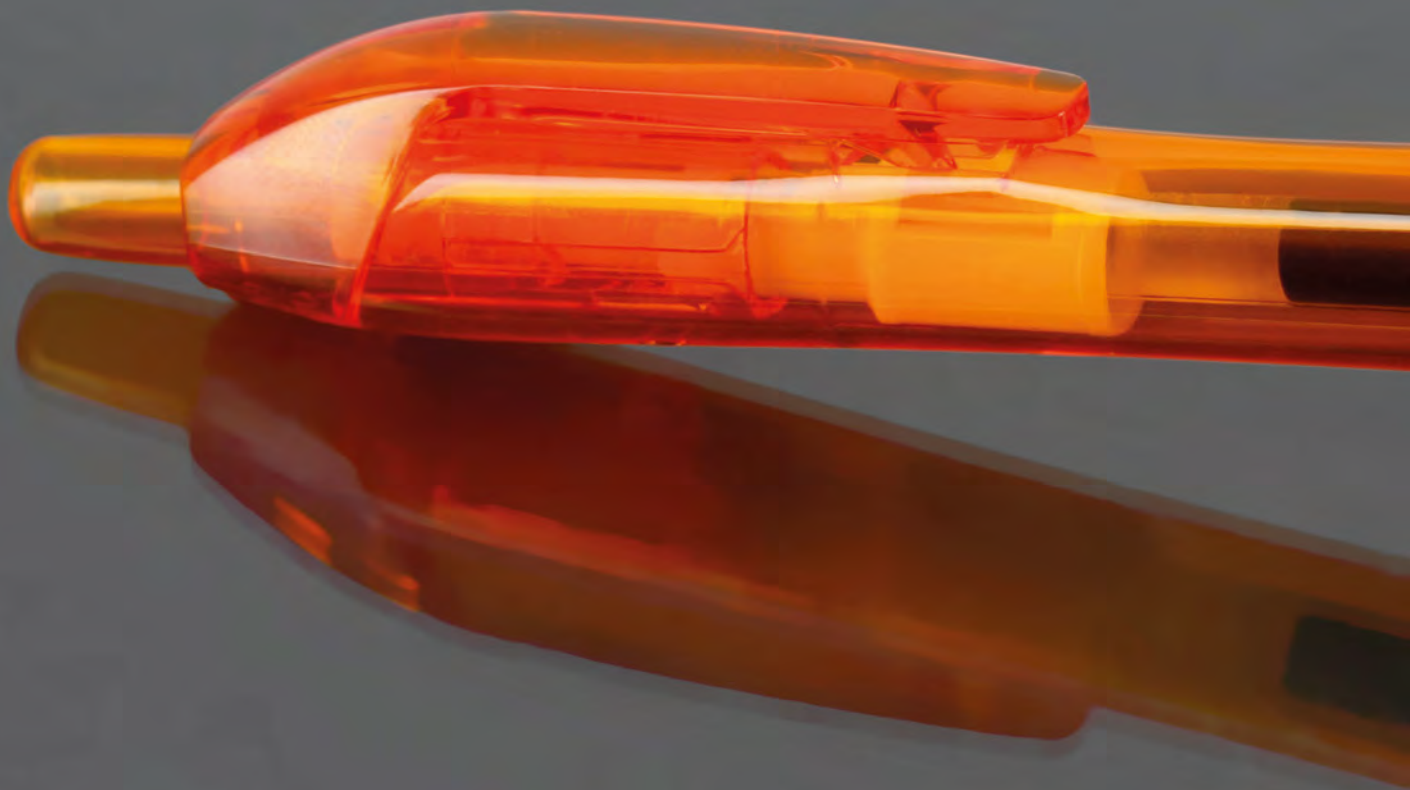

FR > Stylo-bille gel ultra doux, disponible avec une encre bleue ou noire. Mécanisme de rétraction automatique pour éviter les taches sur les poches.

DE > Stylishes, ultraweiches Gelschreibgerät mit blauer oder schwarzer Tinte. Automatische Einzugmechanik, die Verschmutzungen in der Tasche verhindert.

ES > Bolígrafo de gel ultra suave disponible en tinta azul y negro. Mecanismo automático retráctil para evitar manchas en los bolsillos.

IT > Penna gel ultra morbida disponibile in scrittura blu e nero. Meccanismo automatico per evitare macchie nelle tasche.



ROLLERS & GEL
BIC® WRITING INSTRUMENTS



BIC® Intensity® Gel Clic



OPAQUE - 1196

CLEAR - 1196

BIC® WRITING INSTRUMENTS
ROLLERS & GEL

Iconic BIC® Boy is embossed





Colour ink
 Encre de couleur
 Color de la tinta
 Schreibfarbe
 Colore inchiostro

*until stock lasts
 Jusqu'à épuisement du stock / Hasta que se acabe el stock /
 Solange der Vorrat reicht / Fino a esaurimento scorte

MOQ 250v.

Decoration:

Personalisation / Personalización / Dekoration / Decorazione

BIC® Intensity® Gel Clic

1196

A SP: max. 2 col.

B SP: max. 4 col.

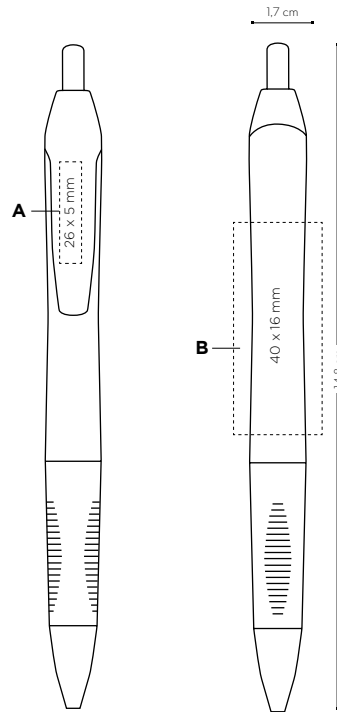

Price (CHF)

BIC® Intensity® Gel Clic	250-499	500-999	1000-2499	2500-4999	5000-9999	10000-24999	25000-49999
1196							
SP	3,04	2,76	2,55	2,38	2,24	①	①

ADDITIONAL IMPRINT CHARGE PER COLOUR & POSITION frais d'impression supplémentaires par couleur et position / cargo por impresión adicional por color y posición / zusätzliche druckkosten pro farbe & position / costo marchio aggiuntivo per colore e posizione

SP	0,18	0,15	0,15	0,15	0,14	①	①
-----------	------	------	------	------	------	---	---

Prices include 1 colour screenprint in one position. Les prix incluent la sérigraphie 1 couleur sur un emplacement. En precio incluye un color en serigrafía en una posición. In den Preisen inbegriffen ist 1 Siebdruck-Farbaufdruck auf 1 Position. I prezzi includono 1 colore a serigrafia in una posizione.

① Price under request. Prix sur demande. Precio bajo consulta. Preis auf Anfrage. Prezzi su richiesta.

Writing modes:

Mode écriture / Modos de escritura / Schreibmodi / Modalità di scrittura

Gel



GØ0,7mm

Printing techniques:

Techniques d'impression / Técnicas de impresión / Drucktechniken / Tecniche di stampa



(SP) SCREEN PRINTING

External packaging:

Emballage externe / Envasado exterior / Außenverpackung / Imballaggio esterno



250 ± 3,7 Kg

 **BIC** Roller Glide® PRO

Water based ink for smooth writing experience.
Cap off time more than 2 hours. Translucid
colour barrel for ink level visibility.

FR > Encre à base d'eau pour un plus grand
confort d'écriture. Le capuchon peut être retiré
pendant plus de 2 heures. Corps de couleur
translucide permettant de voir le niveau d'encre.

ES > Tinta a base de agua para una experiencia
de escritura suave. Se puede tener destapado
durante más de 2 horas. Cuerpo translúcido para
poder ver el nivel de tinta.

DE > Wasserbasierte Tinte für softes
Schreiberlebnis.
Über 2 Stunden Cap-off-Zeit. Transluzenter,
farbiger Schaft für sichtbaren Tintenstand.

IT > Inchiostro a base di acqua per un'esperienza
di scrittura scorrevole. Può restare più di 2 ore
senza cappuccio. Serbatoio colorato trasparente
per verificare il livello dell'inchiostro.





1197



01/04

01/02

Colour ink
Encre de couleur
Color de la tinta
Schreibfarbe
Colore inchiostro

Q 100%

MOA 250v.

Decoration:

Personnalisation / Personalización /
Dekoration / Decorazione

BIC® Roller Glide PRO

1197

A SP: max 1 col.

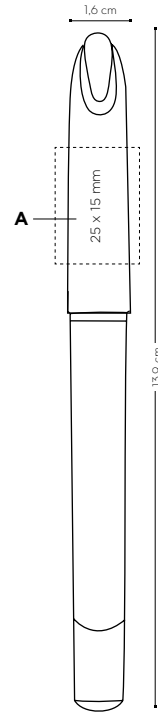

Price (CHF)

BIC® Roller Glide PRO	250-499	500-999	1000-2499	2500-4999	5000-9999	10000-24999	25000-49999
1197							
SP	2,13	1,93	1,79	1,69	1,59	①	①

Prices include 1 colour screenprint in one position. Les prix incluent la sérigraphie 1 couleur sur un emplacement. En precio incluye un color en serigrafía en una posición. In den Preisen inbegriffen ist 1 Siebdruck-Farbaufdruck auf 1 Position. I prezzi includono 1 colore a serigrafia in una posizione.

① Price under request. Prix sur demande. Precio bajo consulta. Preis auf Anfrage. Prezzi su richiesta.

Writing modes:

Mode écriture / Modos de escritura /
Schreibmodi / Modalità di scrittura

Roller



RØ0,7mm

Printing techniques:

Techniques d'impression / Técnicas de impresión /
Drucktechniken / Tecniche di stampa



(SP) SCREEN
PRINTING

External packaging:

Emballage externe / Envasado exterior /
Außenverpackung / Imballaggio esterno



400 ± 2,6 Kg



XS Finestyle

Super-smooth roller with Finestyle ink point. Exclusive britePix™ full-colour printing on the clip also available.

FR > Roller super doux avec pointe feutre fine. Désormais disponible aussi en version britePix™ toutes couleurs sur le clip.

ES > Roller súper fluido con punta Finestyle. Ahora también disponible con britePix™ en el clip.

DE > Extrem sanft gleitender Rollerball mit Finestyle-Spitze. Nun auch erhältlich mit britePix™ Vollfarbkonzept auf dem Clip.

IT > Roller a scrittura ultra-fluida con punta Finestyle. Adesso disponibile anche con concetto di stampa a colori britePix™ sulla clip.







OPAQUE - 1851

OPAQUE / CLEAR - 1851

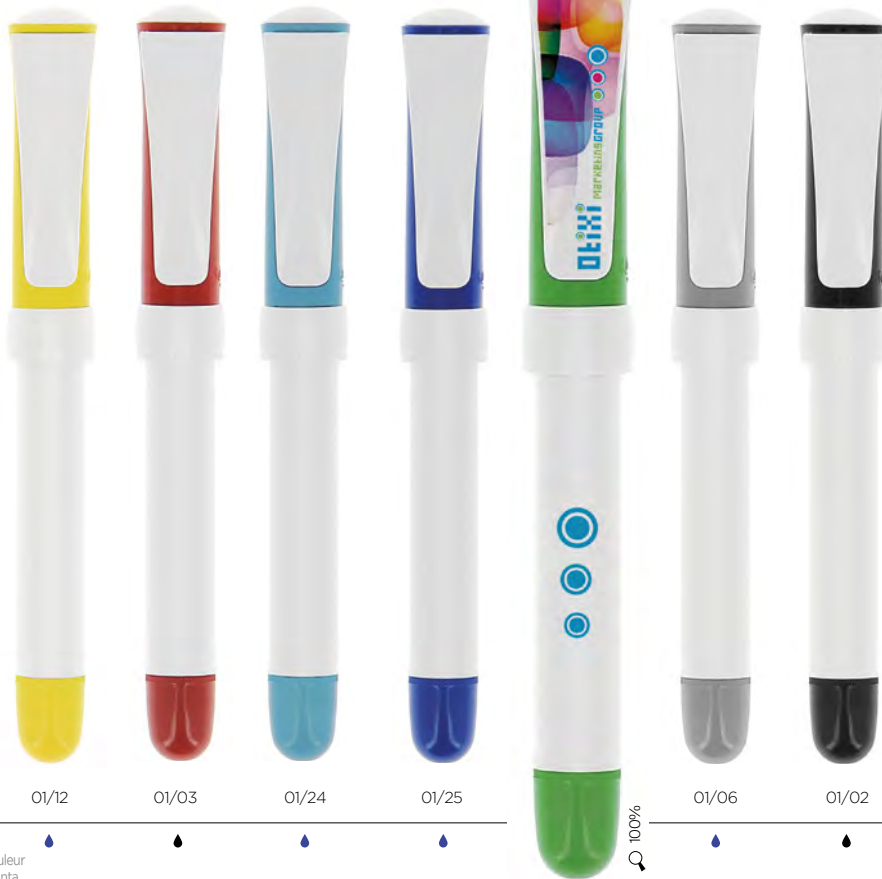

01/12

01/03

01/24

01/25

01/05

01/06

01/02

01/89

Colour ink
Encre de couleur
Color de la tinta
Schreibfarbe
Colore inchiostro

100%

100%

*48h not available for britePix™ decoration *48h non disponibile en impression britePix™ / *48h no disponible para personalización britePix™ / *britePix™ Druck ausgeschlossen / *48 h non disponibile per personalizzazione britePix™



MOA 250v.

Decoration:

Personnalisation / Personalización / Dekoration / Decorazione

BIC® XS Finestyle

1851

A PD: max 2 col.

B SP: max 2 col.

C BP: full-colour

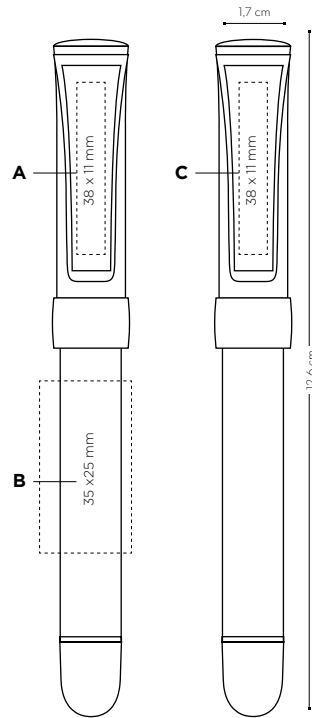

Price (CHF)

BIC® XS Finestyle	250-499	500-999	1000-2499	2500-4999	5000-9999	10000-24999	25000-49999
1851							
SP/PD	1,97	1,79	1,68	1,56	1,45	①	①
BP	2,23	2,04	1,91	1,78	1,66	①	①

ADDITIONAL IMPRINT CHARGE PER COLOUR & POSITION frais d'impression supplémentaires par couleur et position / cargo por impresión adicional por color y posición / zusätzliche druckkosten pro farbe & position / costo marchio aggiuntivo per colore e posizione

SP/PD	0,18	0,15	0,15	0,15	0,14	①	①
BP Texture	0,20	0,17	0,16	0,16	0,15	①	①

Prices include one imprint in one position according to specified technique. Les prix incluent une impression sur un emplacement avec la technique spécifiée / Los precios incluyen una impresión en una posición acorde con la técnica especificada / In den Preisen inbegriffen ist ein Aufdruck auf einer Position gemäß angegebener Technik / I prezzi includono una stampa in una posizione a seconda della tecnica specificata.

① Price under request. Prix sur demande. Precio bajo consulta. Preis auf Anfrage. Prezzi su richiesta.

Exact colour match:

Correspondance exacte des couleurs / Color exacto / Exakte Farbübereinstimmung / Esatta corrispondenza di colore

≥ 10.000 units

Writing modes:

Mode écriture / Modos de escritura / Schreibmodi / Modalità di scrittura

Finestyle



FSØ0,7mm

Printing techniques:

Techniques d'impression / Técnicas de impresión / Drucktechniken / Tecniche di stampa



(SP) SCREEN PRINTING



(PD) PAD PRINTING



(BP) britePix™



External packaging:

Emballage externe / Envasado exterior / Außenverpackung / Imballaggio esterno



250 ± 2,8 Kg



MADE IN SPAIN

 Brite Liner® Grip

Highlight your message with precision and control thanks to the textured rubberised grip.



FR > Donnez de l'impact à votre message par la précision et le contrôle, grâce au grip en caoutchouc.

DE > Markieren Sie Ihre Botschaft präzise und kontrolliert dank der strukturierten, gummierten Griffzone.

ES > Resalta tu mensaje con precisión y control gracias al grip de goma.

IT > Fai risaltare il tuo messaggio con precisione e controllo grazie all'impugnatura in gomma.



Brite Liner® Grip



New Colour!

New Colour!

New Colour!

New Colour!

1192



12



10



14

100%



24



59



85



83



3G



8D

Colour ink
Encre de couleur
Color de la tinta
Schreibfarbe
Colore inchiostro



MOQ 250v.

Decoration:

Personalisation / Personalización /
Dekoration / Decorazione

BIC® Brite Liner® Grip

1192

A/B SP: max. 3 col.

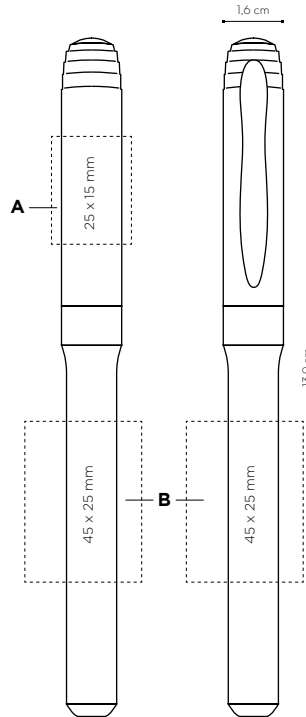

HIGHLIGHTERS & MARKERS
BIC® WRITING INSTRUMENTS

	Price (CHF)						
BIC® Brite Liner® Grip	250-499	500-999	1000-2499	2500-4999	5000-9999	10000-24999	25000-49999
1192							
SP	1,68	1,55	1,41	1,32	1,24	①	①

ADDITIONAL IMPRINT CHARGE PER COLOUR & POSITION frais d'impression supplémentaires par couleur et position / cargo por impresión adicional por color y posición / zusätzliche druckkosten pro farbe & position / costo marchio aggiuntivo per colore e posizione

SP	0,18	0,15	0,15	0,15	0,14	①	①
-----------	------	------	------	------	------	---	---

Prices include 1 colour screenprint in one position. Les prix incluent la sérigraphie 1 couleur sur un emplacement. En precio incluye un color en serigrafía en una posición. In den Preisen inbegriffen ist 1 Siebdruck-Farbaufdruck auf 1 Position. I prezzi includono 1 colore a serigrafia in una posizione.

① Price under request. Prix sur demande. Precio bajo consulta. Preis auf Anfrage. Prezzi su richiesta.

Writing modes:

Mode écriture / Modos de escritura /
Schreibmodi / Modalità di scrittura

Highlighter



HL

Printing techniques:

Techniques d'impression / Técnicas de impresión /
Drucktechniken / Tecniche di stampa



(SP) SCREEN
PRINTING

External packaging:

Emballage externe / Envasado exterior /
Außenverpackung / Imballaggio esterno



250 ± 2,8 Kg





BIC® markers offer you products specifically designed to write in highly visible way and mark on surfaces or material that other writing instruments cannot mark on. Make your ideas visible and express yourself whatever the surface with BIC® Markers.



FR > Les marqueurs BIC® vous proposent des produits spécifiquement conçus pour écrire avec une haute visibilité, et sur des surfaces ou des matériaux sur lesquels d'autres instruments d'écriture ne peuvent être utilisés. Donnez de la visibilité à vos idées et exprimez-vous sur n'importe quelle surface avec les marqueurs BIC®.

ES > BIC® te ofrece productos especialmente diseñados para escribir de una manera altamente visible y marcar superficies o materiales que otros instrumentos de escritura no pueden marcar. Haz tus ideas visibles y expresasate a ti mismo en cualquier superficie con los marcadores BIC®

DE > BIC®-Textmarker bieten Produkte, die speziell konzipiert wurden, um besonders sichtbar zu schreiben und auf Oberflächen oder Materialien zu markieren, wo anderes Schreibgerät passen muss. Machen Sie Ihre Ideen sichtbar, bringen Sie sie zum Ausdruck, egal auf welcher Fläche, mit BIC® Textmarkern.

IT > BIC® offre prodotti specificamente ideati per scrivere in modo particolarmente visibile e lasciare il segno su superfici o materiali su cui altri strumenti di scrittura non funzionano. Esprimiti e dai visibilità alle tue idee su qualsiasi tipo di superficie con i pennarelli BIC®.



BIC® Velleda® White Board Marker Fine



1651



01/03

01/04

01/02

01/05

Colour ink
Encre de couleur
Color de la tinta
Schreibfarbe
Colore inchiostro



100%

MOA 500v.

Decoration:

Personalisation / Personalización /
Dekoration / Decorazione

BIC® Velleda® White Board
Marker Fine

1651

A SP: max. 1 col.

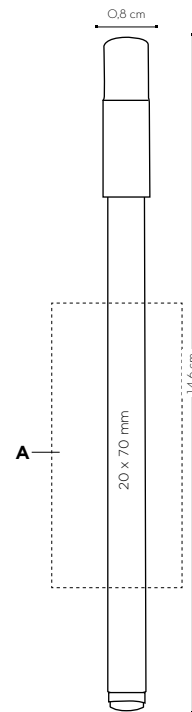

Price (CHF)

BIC® Velleda® White Board Marker Fine 1651	250-499	500-999	1000-2499	2500-4999	5000-9999	10000-24999	25000-49999
SP	-	0,62	0,56	0,53	0,49	0,46	0,43

Prices include 1 colour screenprint in one position. Les prix incluent la sérigraphie 1 couleur sur un emplacement. En precio incluye un color en serigrafía en una posición. In den Preisen inbegriffen ist 1 Siebdruck-Farbaufdruck auf 1 Position. I prezzi includono 1 colore a serigrafia in una posizione.

Writing modes:

Mode écriture / Modos de escritura /
Schreibmodi / Modalità di scrittura

Marker



MK

Printing techniques:

Techniques d'impression / Técnicas de impresión /
Drucktechniken / Tecniche di stampa



(SP) SCREEN
PRINTING

External packaging:

Emballage externe / Envasado exterior /
Außenverpackung / Imballaggio esterno



500 ± 3,2 Kg



MADE IN
FRANCE



BIC Velleda White Board Marker Grip



New Colour!
New Colour!
New Colour!

1213



Colour ink
Encre de couleur
Color de la tinta
Schreibfarbe
Colore inchiostro

01/03 01/05 01/04

01/02



MOQ 250v.

Decoration:

Personalisation / Personalización /
Dekoration / Decorazione

BIC Velleda White Board
Marker Grip 1213

A/B SP: max. 3 col.

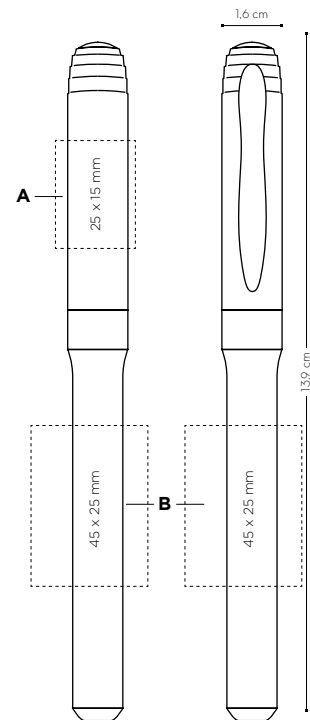

Price (CHF)

BIC Velleda White Board Marker Grip 1213	250-499	500-999	1000-2499	2500-4999	5000-9999	10000-24999	25000-49999
SP	1,67	1,50	1,39	1,30	1,22	①	①

ADDITIONAL IMPRINT CHARGE PER COLOUR & POSITION frais d'impression supplémentaires par couleur et position / cargo por impresión adicional por color y posición / zusätzliche druckkosten pro farbe & position / costo marchio aggiuntivo per colore e posizione

SP	0,18	0,15	0,15	0,15	0,14	①	①
----	------	------	------	------	------	---	---

Prices include 1 colour screenprint in one position. Les prix incluent la sérigraphie 1 couleur sur un emplacement. En precio incluye un color en serigrafía en una posición. In den Preisen inbegriffen ist 1 Siebdruck-Farbaufdruck auf 1 Position. I prezzi includono 1 colore a serigrafia in una posizione.

① Price under request. Prix sur demande. Precio bajo consulta. Preis auf Anfrage. Prezzi su richiesta.

Writing modes:

Mode écriture / Modos de escritura /
Schreibmodi / Modalità di scrittura

White board marker



MK

Printing techniques:

Techniques d'impression / Técnicas de impresión /
Drucktechniken / Tecniche di stampa



(SP) SCREEN
PRINTING

External packaging:

Emballage externe / Envasado exterior /
Außenverpackung / Imballaggio esterno



250 ± 2,7 Kg

HIGHLIGHTERS & MARKERS
BIC® WRITING INSTRUMENTS

BIC® Mark-it Permanent Marker



New Colour!
New Colour!

1214



01/03

01/05

01/02

01/04

Colour ink
Encre de couleur
Color de la tinta
Schreibfarbe
Colore inchiostro

100%

MOA 250v.

Decoration:

Personnalisation / Personalización /
Dekoration / Decorazione

BIC® Mark-it Permanent
Marker

1214

A/B SP: max. 3 col.

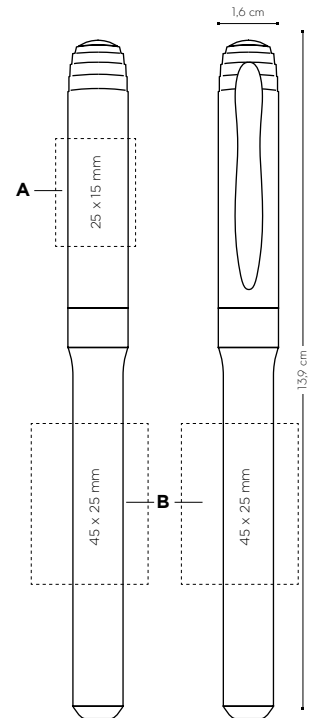

Price (CHF)

BIC® Mark-it
Permanent Marker

250-499 500-999 1000-2499 2500-4999 5000-9999 10000-24999 25000-49999

1214

SP	1,67	1,50	1,39	1,30	1,22	①	①
----	------	------	------	------	------	---	---

ADDITIONAL IMPRINT CHARGE PER COLOUR & POSITION frais d'impression supplémentaires par couleur et position / cargo por impresión adicional por color y posición / zusätzliche druckkosten pro farbe & position / costo marchio aggiuntivo per colore e posizione

SP	0,18	0,15	0,15	0,15	0,14	①	①
----	------	------	------	------	------	---	---

Prices include 1 colour screenprint in one position. Les prix incluent la sérigraphie 1 couleur sur un emplacement. En precio incluye un color en serigrafía en una posición. In den Preisen inbegriffen ist 1 Siebdruck-Farbaufdruck auf 1 Position. I prezzi includono 1 colore a serigrafia in una posizione.

① Price under request. Prix sur demande. Precio bajo consulta. Preis auf Anfrage. Prezzi su richiesta.

Writing modes:

Mode écriture / Modos de escritura /
Schreibmodi / Modalità di scrittura

Printing techniques:

Techniques d'impression / Técnicas de impresión /
Drucktechniken / Tecniche di stampa

External packaging:

Emballage externe / Envasado exterior /
Außenverpackung / Imballaggio esterno

Marker



MK



(SP) SCREEN
PRINTING



250 ± 2,8 Kg



BIC® Permanent Marker **eco**olutions®



ecoolutions® Made with 51% recycled material.
The percentage is calculated based on the total weight of the product.
Add the Möbius loop to your artwork at no additional charge. Please be sure to specify "Print the Möbius loop" on your order. (Möbius loop imprint defaults to left-hand hand corner.)

FR > Le pourcentage est calculé sur le poids total du produit.
Ajoutez l'anneau Möbius à votre article sans frais supplémentaire. N'oubliez pas de préciser « Imprimer l'anneau Möbius » dans votre commande. (L'anneau Möbius est imprimé par défaut dans le coin supérieur gauche)

ES > El porcentaje está calculado basado en el peso total del producto.
Añade el Möbius loop a tu arte final sin cargo adicional. Por favor asegúrate de especificar "imprimir el Möbius loop" en tu pedido. (La impresión del Möbius loop a mano izquierda en la esquina)

DE > Der Prozentsatz ist auf der Grundlage des Gesamtgewichts des Produkts berechnet. Zu Artwork Möbius-Loop hinzufügen, ohne Zusatzkosten.
Vergessen Sie nicht "Möbius-Loop drucken" auf der Bestellung anzugeben (Möbius-Loop-Aufdruck standardmäßig auf der linken Ecke).

IT > La percentuale è calcolata in base al peso totale del prodotto.
Aggiungi l'anello di Möbius al tuo disegno senza costi aggiuntivi. Assicurati di specificare "Stampare anello di Möbius" nel tuo ordine. (La stampa dell'anello di Möbius va in default nell'angolo sinistro)



1210



MOQ 250v.

Decoration:

Personalisation / Personalización / Dekoration / Decorazione

BIC® Permanent Marker **eco**olutions®
1210

A SP: max. 1 col.

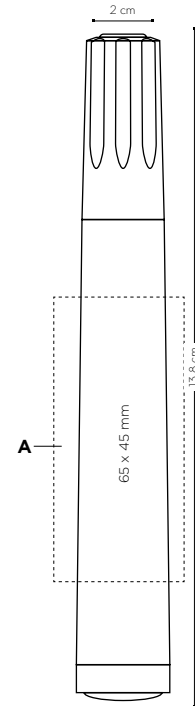

Colour ink
Encre de couleur
Color de la tinta
Schreibfarbe
Colore inchiostro

O2

O2

100%

ecoolutions® Made with 51% recycled material.

Price (CHF)

BIC® Permanent Marker eco olutions® 1210	250-499	500-999	1000-2499	2500-4999	5000-9999	10000-24999	25000-49999
SP	1,97	1,79	1,66	1,55	1,45	①	①

Prices include 1 colour screenprint in one position. Les prix incluent la sérigraphie 1 couleur sur un emplacement. In den Preisen inbegriffen ist 1 Siebdruck-Farbaufdruck auf 1 Position. I prezzi includono 1 colore a serigrafia in una posizione.

① Price under request. Prix sur demande. Precio bajo consulta. Preis auf Anfrage. Prezzi su richiesta.

Writing modes:

Mode écriture / Modos de escritura / Schreibmodi / Modalità di scrittura

Marker



MK

Printing techniques:

Techniques d'impression / Técnicas de impresión / Drucktechniken / Tecniche di stampa



(SP) SCREEN PRINTING

External packaging:

Emballage externe / Envasado exterior / Außenverpackung / Imballaggio esterno



250 ± 2,6 Kg



MADE IN FRANCE

HIGHLIGHTERS & MARKERS
BIC® WRITING INSTRUMENTS



Stay sharp with this first-class mechanical pencil!
It is solid and resistant, never needs sharpening
and writes smoother and darker than ever!

FR > Toujours prêt avec ce
porte-mines de grande qualité.
Il est solide et la mine est
résistante. Il n'a pas besoin d'être
taillé et offre une écriture plus
fluide et plus intense que jamais !

ES > Siempre preparado con este
portaminas de calidad superior.
Es sólido y resistente, no necesita
afilarse y escribe más fluido e
intenso que nunca!

DE > Stets schreibbereit mit
diesem Qualitäts-Druckbleistift.
Solide und resistent, ohne
Anspitzen, schreibt dieser Stift
leichter und kräftiger denn je!

IT > Non perderti questo
portamine di prima categoria.
Compatto e resistente, non si
tempera e scrive più fluido e
scuro che mai!

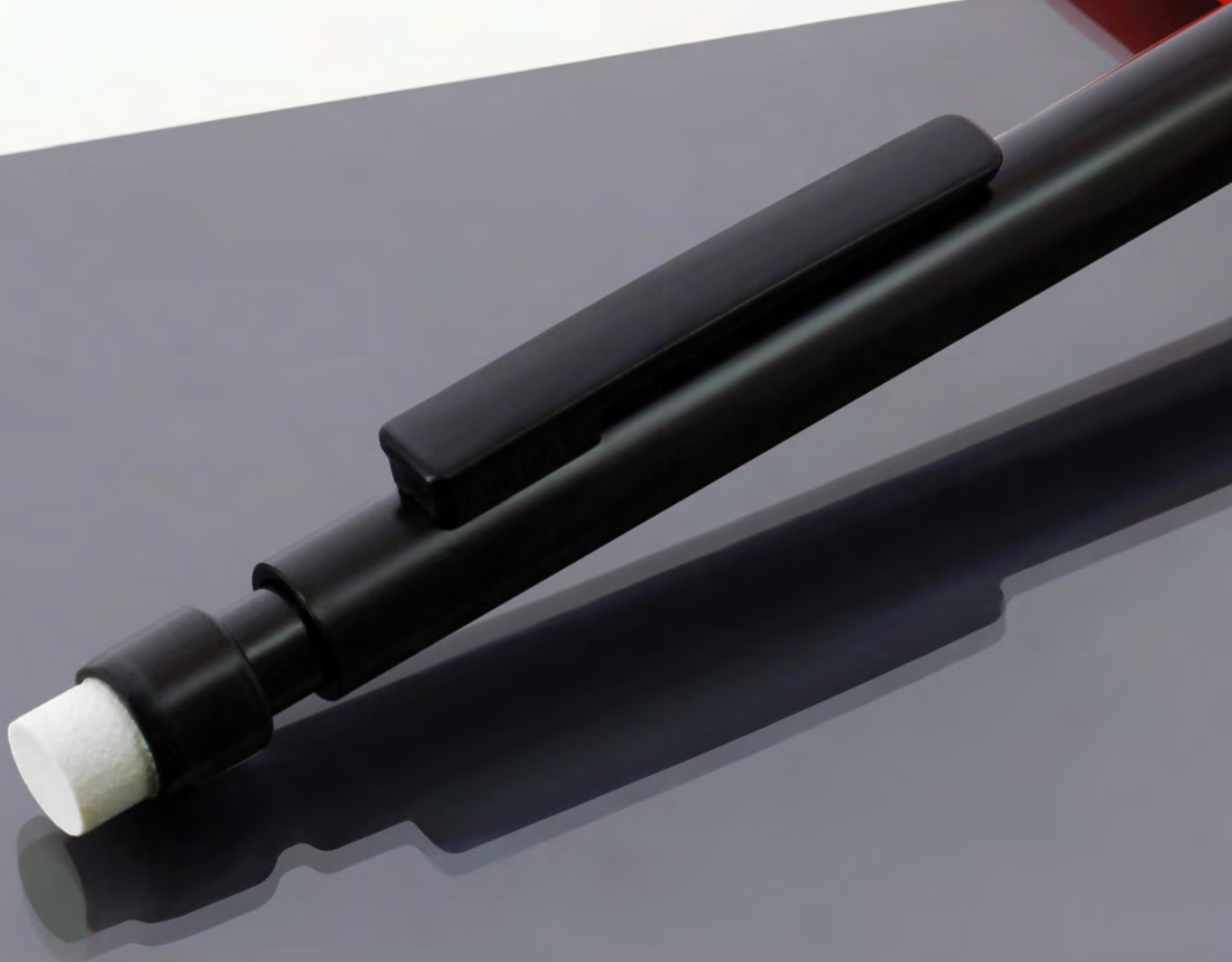





BIC® Matic®
OPAQUE - 1120



BIC® WRITING INSTRUMENTS
PENCILS





ecolutions® Made with 65% recycled material.
 The percentage is calculated based on the total weight of the product.
 Add the Möbius loop to your artwork at no additional charge. Please be sure to specify "Print the Möbius loop" on your order. (Möbius loop imprint defaults to left-hand hand corner.)



PENCILS
BIC® WRITING INSTRUMENTS

FR > Le pourcentage est calculé sur le poids total du produit.
 Ajoutez l'anneau Möbius à votre article sans frais supplémentaire. N'oubliez pas de préciser « Imprimer l'anneau Möbius » dans votre commande. (L'anneau Möbius est imprimé par défaut dans le coin supérieur gauche)

ES > El porcentaje está calculado basado en el peso total del producto.
 Añade el Möbius loop a tu arte final sin cargo adicional. Por favor asegúrate de especificar "imprimir el Möbius loop" en tu pedido. (La impresión del Möbius loop a mano izquierda en la esquina)

DE > Der Prozentsatz ist auf der Grundlage des Gesamtgewichts des Produkts berechnet.
 Zu Artwork Möbius-Loop hinzufügen, ohne Zusatzkosten.
 Vergessen Sie nicht "Möbius-Loop drucken" auf der Bestellung anzugeben (Möbius-Loop-Aufdruck standardmäßig auf der linken Ecke).

IT > La percentuale è calcolata in base al peso totale del prodotto.
 Aggiungi l'anello di Möbius al tuo disegno senza costi aggiuntivi. Assicurati di specificare "Stampare anello di Möbius" nel tuo ordine. (La stampa dell'anello di Möbius va in default nell'angolo sinistro)





BIC® Matic® Quartz
OPAQUE - 1121

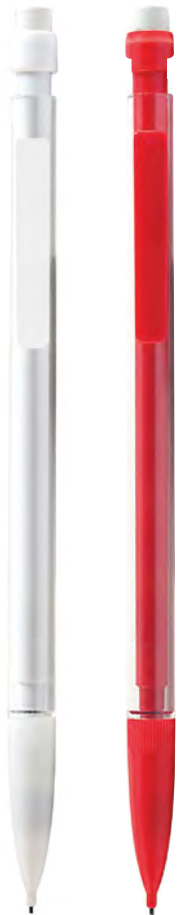

51/01

51/03



51/04

100%

BIC® Matic® Quartz Metallic



51/07

51/18

BIC® Matic® Grip
OPAQUE - 1122



01/04

01/02

BIC® Matic® Grip
Metallic



02/02

100%

BIC® WRITING INSTRUMENTS

PENCILS

MOQ 500v.

Decoration:

Personalisation / Personalización / Dekoration / Decorazione

BIC® Matic®
1120
e@colutions® 1E40

BIC® Matic®
Quartz & Metallic
1121

A SP: max. 1 col. (not available for BIC® Matic® Quartz)
B/C SP: max. 2 col.

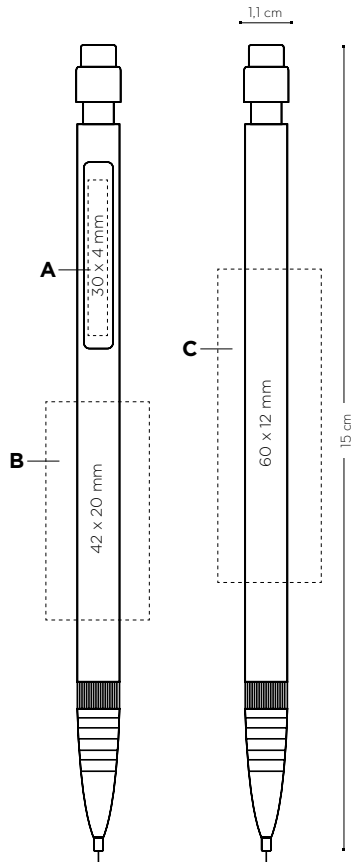

BIC® Matic® Grip & Metallic
1122
A SP: max. 1 col.
B/C SP: max. 2 col.

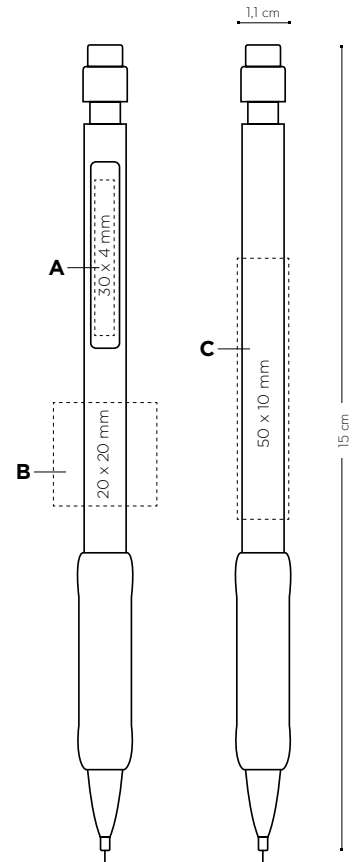

e@colutions® version & STD
at the same price!



Price (CHF)

	500-4999	1000-2499	2500-4999	5000-9999	10000-24999	25000-49999
BIC® Matic® Quartz & Metallic 1120/e@colutions® 1E40	0.87	0.82	0.76	0.71	0.67	0.62
1121	0.95	0.87	0.82	0.77	0.72	0.68

ADDITIONAL IMPRINT CHARGE PER COLOUR & POSITION frais d'impression supplémentaires par couleur et position / cargo por impresión adicional por color y posición / zusätzliche druckkosten pro farbe & position / costo marchio aggiuntivo per colore e posizione

SP	0,15	0,15	0,15	0,14	0,13	0,13
----	------	------	------	------	------	------

Prices include 1 colour screenprint in one position. Les prix incluent la sérigraphie 1 couleur sur un emplacement. En precio incluye un color en serigrafía en una posición. In den Preisen inbegriffen ist 1 Siebdruck-Farbaufdruck auf 1 Position. I prezzi includono 1 colore a serigrafia in una posizione.

Price (CHF)

	500-4999	1000-2499	2500-4999	5000-9999	10000-24999	25000-49999
BIC® Matic® Grip & Metallic 1122	1.05	0.98	0.92	0.85	0.79	0.74

ADDITIONAL IMPRINT CHARGE PER COLOUR & POSITION frais d'impression supplémentaires par couleur et position / cargo por impresión adicional por color y posición / zusätzliche druckkosten pro farbe & position / costo marchio aggiuntivo per colore e posizione

SP	0,15	0,15	0,15	0,14	0,13	0,13
----	------	------	------	------	------	------

Prices include 1 colour screenprint in one position. Les prix incluent la sérigraphie 1 couleur sur un emplacement. En precio incluye un color en serigrafía en una posición. In den Preisen inbegriffen ist 1 Siebdruck-Farbaufdruck auf 1 Position. I prezzi includono 1 colore a serigrafia in una posizione.

Writing modes:

Mode écriture / Modos de escritura / Schreibmodi / Modalità di scrittura

Printing techniques:

Techniques d'impression / Técnicas de impresión / Drucktechniken / Tecniche di stampa

External packaging:

Emballage externe / Envasado exterior / Außenverpackung / Imballaggio esterno



MP
Ø0,7mm



(SP) SCREEN
PRINTING



500 ± 3,1 Kg



MADE IN
FRANCE

Wood-free pencil made with recycled synthetic resin material, that will not splinter in the event of breaking. Ultra-resistant HB graphite lead and excellent erasability!

FR > Crayon papier en résine synthétique, sans bois, qui ne fait pas d'éclat en cas de casse. Mine graphite HB ultra-résistante qui s'efface rapidement !

ES > Lápiz de grafito de resina sintética, sin madera, hecho con un material reciclado, que no se astilla en caso de rotura. Resistente mina de grafito HB y excelente calidad de borrado!

DE > Holzfreier Bleistift aus recyceltem Kunstharzmaterial, das nicht splittert, wenn es bricht. Extrem robuste HB-Graphitmine! Lässt sich hervorragend ausradieren!

IT > Matita senza legno realizzata in resina sintetica riciclata che non produce schegge in caso di rottura. Mina HB in grafite ultrasensibile ed eccellente cancellabilità!





GRAPHITE PENCIL CUT END
1150



01

03

04

20

02

GRAPHITE PENCIL WITH ERASER
1151

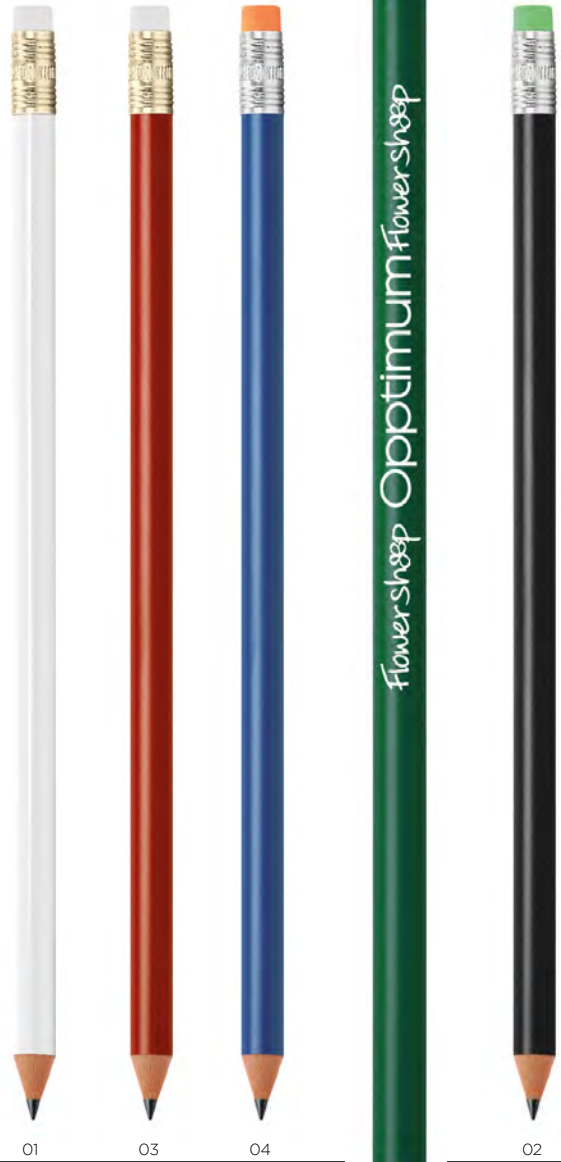

01

03

04

20

02



100%

100%



PENCILS
BIC® WRITING INSTRUMENTS



Digital Printing!

Digital
GRAPHITE PENCIL
CUT END - 1150



01



Metallic Digital
GRAPHITE PENCIL
CUT END - 1962



47



Digital
GRAPHIC PENCIL
WITH ERASER - 1151



01



Metallic Digital
GRAPHIC PENCIL
WITH ERASER - 1960



47



MOQ 500v.

MIX & MATCH



Standard colours combination

Combinaison de couleurs standards / Combinación de colores estandar / Standardfarbkombination / Combinazione colori standard

Eraser

Gomme / Goma / Radiergummi / Gomma

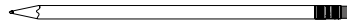

Ferrule

Virole / Ferrula / Ferrule / Ghiera

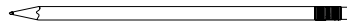

OPAQUE 47 26 2C 34 02

Barrel

Corps / Cuerpo / Schaft / Fusto

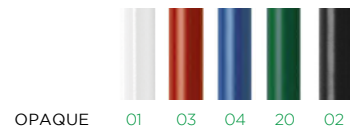

METALLIC



GRAPHITE PENCIL CUT END



Made with 54% recycled plastic

GRAPHITE PENCIL WITH ERASER



Made with 46% recycled plastic

The percentage is calculated based on the total weight of the product.

Add the Möbius loop to your artwork at no additional charge. Please be sure to specify "Print the Möbius loop" on your order. (Möbius loop imprint defaults to left-hand hand corner.)

FR > Le pourcentage est calculé sur le poids total du produit. Ajoutez l'anneau Möbius à votre article sans frais supplémentaire. N'oubliez pas de préciser « Imprimer l'anneau Möbius » dans votre commande. (L'anneau Möbius est imprimé par défaut dans le coin supérieur gauche)

ES > El porcentaje está calculado basado en el peso total del producto. Añade el Möbius loop a tu arte final sin cargo adicional. Por favor asegúrate de especificar "imprimir el Möbius loop" en tu pedido. (La impresión del Möbius loop a mano izquierda en la esquina)

DE > Der Prozentsatz ist auf der Grundlage des Gesamtgewichts des Produkts berechnet. Zu Artwork Möbius-Loop hinzufügen, ohne Zusatzkosten. Vergessen Sie nicht "Möbius-Loop drucken" auf der Bestellung anzugeben (Möbius-Loop-Aufdruck standardmäßig auf der linken Ecke).

IT > La percentuale è calcolata in base al peso totale del prodotto. Aggiungi l'anello di Möbius al tuo disegno senza costi aggiuntivi. Assicurati di specificare "Stampare anello di Möbius" nel tuo ordine. (La stampa dell'anello di Möbius va in default nell'angolo sinistro)

Writing modes:

Mode écriture / Modos de escritura / Schreibmodi / Modalità di scrittura



PC HB Ø2,3mm

Printing techniques:

Techniques d'impression / Técnicas de impresión / Drucktechniken / Tecniche di stampa



(SP) SCREEN PRINTING



(DG) DIGITAL

External packaging:

Emballage externe / Envasado exterior / Außenverpackung / Imballaggio esterno



500 ± 3,5 Kg



MADE IN FRANCE

PENCILS BIC® WRITING INSTRUMENTS



BIC® EVOLUTION® eCOlutions®
PENCIL WITH CUT END
1150

BIC® EVOLUTION® eCOlutions®
PENCIL WITH ERASER
1151

A SP: max. 1 col.
B SP: max. 2 col.

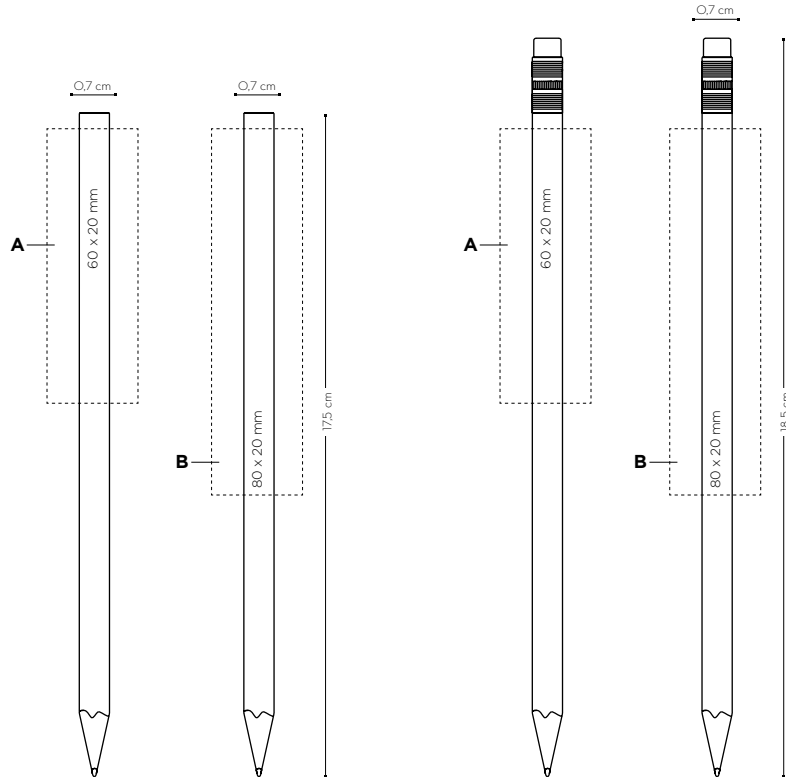

BIC® WRITING INSTRUMENTS
PENCILS

Price (CHF)

BIC® EVOLUTION® eCOlutions®	500-111	1000-2411	2500-4111	5000-1111	10000-2411	25000-4111
PENCIL WITH CUT END / 1150						
SP	0,49	0,47	0,44	0,41	0,39	0,37
PENCIL WITH ERASER / 1151						
SP	0,84	0,78	0,74	0,69	0,64	0,60

ADDITIONAL IMPRINT CHARGE PER COLOUR & POSITION frais d'impression supplémentaires par couleur et position / cargo por impresión adicional por color y posición / zusätzliche druckkosten pro farbe & position / costo marchio aggiuntivo per colore e posizione

SP	0,15	0,15	0,15	0,14	0,13	0,13
-----------	------	------	------	------	------	------

Prices include 1 colour screenprint in one position. Les prix incluent la sérigraphie 1 couleur sur un emplacement. En precio incluye un color en serigrafía en una posición. In den Preisen inbegriffen ist 1 Siebdruck-Farbaufdruck auf 1 Position. I prezzi includono 1 colore a serigrafia in una posizione.

External packaging:

Emballage externe / Envasado exterior / Außenverpackung / Imballaggio esterno



500 ± 3,5 Kg



MADE IN FRANCE



BIC® Evolution® **ecolutions®**
 PENCIL WITH CUT END
 1150 Digital
 1962 Metallic Digital

BIC® Evolution® **ecolutions®**
 PENCIL WITH ERASER DIGITAL
 1151
 PENCIL WITH ERASER
 METALLIC DIGITAL
 1960

A DG: full-colour (area for images)
B DG: full-colour (area for text)

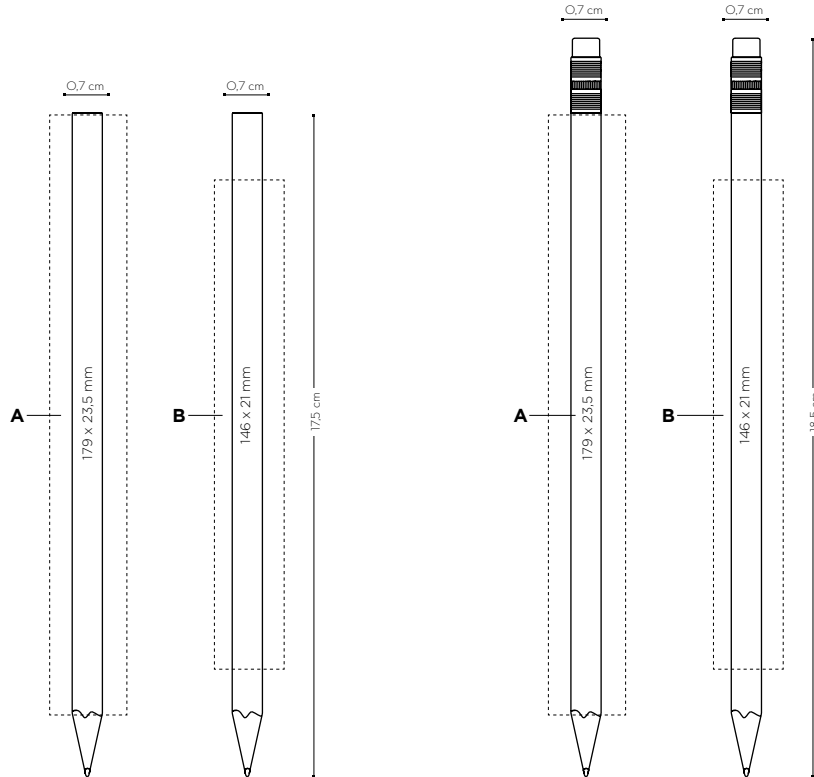

PENCILS
 BIC® WRITING INSTRUMENTS

	Price (CHF)							
	250-499	500-999	1000-2499	2500-4999	5000-9999	10000-24999	25000-49999	
PENCIL WITH CUT END DIGITAL / 1150								
DG	-	0,77	0,74	0,68	0,63	①	①	
PENCIL WITH CUT END METALLIC / 1962								
DG	-	0,92	0,86	0,79	0,74	①	①	
PENCIL WITH ERASER DIGITAL / 1151								
DG	-	1,12	1,05	0,98	0,91	①	①	
PENCIL WITH ERASER METALLIC DIGITAL / 1960								
DG	-	1,27	1,18	1,10	1,02	①	①	

Prices include digital imprint on barrel. Les prix incluent l'impression numérique sur le corps. El precio incluye impresión digital en el cuerpo. Preise beinhalten Digitaldruck auf dem Schaft. I prezzi comprendono la stampa digitale sul fusto.
 ① Price under request. Prix sur demande. Precio bajo consulta. Preis auf Anfrage. Prezzi su richiesta.

External packaging:
 Emballage externe / Envasado exterior /
 Außenverpackung / Imballaggio esterno

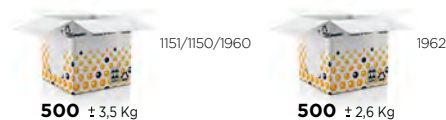

Sprout®



Customized Sprout pencils are used by companies and organisations all over the world to spread their sustainability message. Once the pencil is too short to write with, plant the stub and watch your message turn into a pot of beautiful herbs, flowers or vegetables.

FR > Les crayons Sprout personnalisables sont utilisés par les entreprises et les organisations du monde entier pour communiquer leur respect de l'environnement. Une fois que le crayon est trop court pour écrire, plantez-le et regardez votre message se transformer en superbe pot d'herbes aromatiques, de fleurs ou de légumes.

ES > Los lápices Sprout personalizables son usados por la compañías y organizaciones en todo el mundo para difundir su mensaje de sostenibilidad. Una vez que el lápiz es demasiado corto para escribir, plántalo por la parte de arriba y mira como tu mensaje se convierte en una maceta de hermosas hierbas, flores o vegetales.

DE > Die kundenspezifisch anpassbaren Sprout-Bleistifte werden von Unternehmen und Organisationen weltweit genutzt, um ihre Nachhaltigkeitsbotschaft zu übermitteln. Wenn der Stift zum Schreiben zu kurz geworden ist, pflanzen Sie den Stummel ein und sehen Sie, wie Ihre Botschaft zu einem Topf schöner Kräuter, Blumen oder Gemüse wird.

IT > Le matite personalizzate Sprout sono utilizzate da società e organizzazioni di tutto il mondo per diffondere il proprio messaggio di sostenibilità. Quando la matita diventa troppo corta per scrivere, si può piantare trasformando il proprio messaggio in un bellissimo vaso di erbe aromatiche, fiori o verdure.





SPROUT™



Sprouta Pencil

Combine them!

Non-customizable cardboard

Customizable cardboard

53062



Non printed barrel



Printed barrel

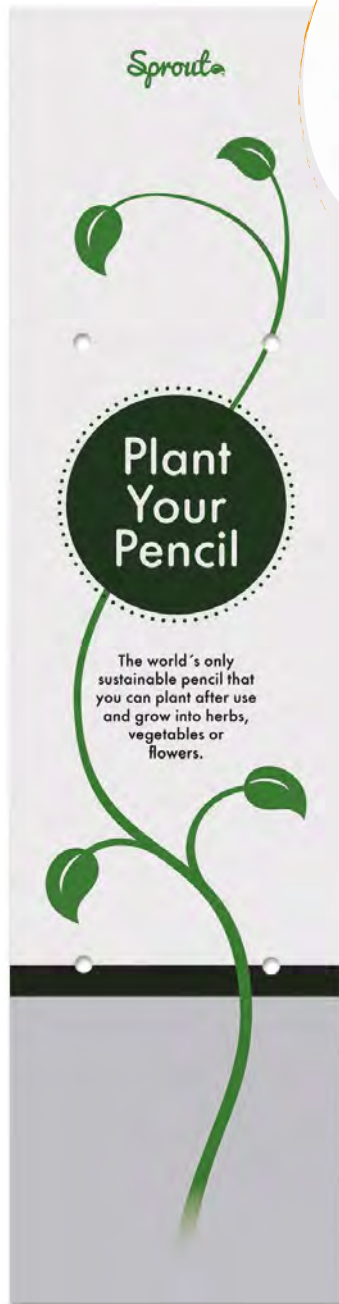

Standard cardboard packaging



back

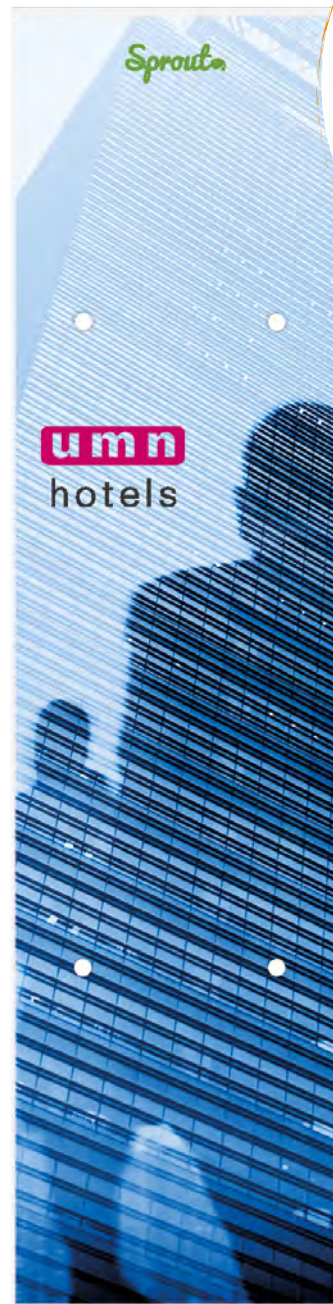

Personalised cardboard packaging



back

80%

FR > Emballage non personnalisable
Emballage personnalisable !

ES > Cartón no personalizable
¡Cartón personalizable!

DE > Pappe kann nicht an
Kundenwünsche angepasst werden!
Pappe kann an Kundenwünsche
angepasst werden!

IT > Cartone non personalizzabile
Cartone personalizzabile!





MOQ 500

MOQ 1000 (Non printed pencil + personalised cardboard packaging)

Decoration:

Personnalisation / Personalización / Dekoration / Decorazione

Sprout™ Pencil

53062

A LE

B DG: 4-colour process

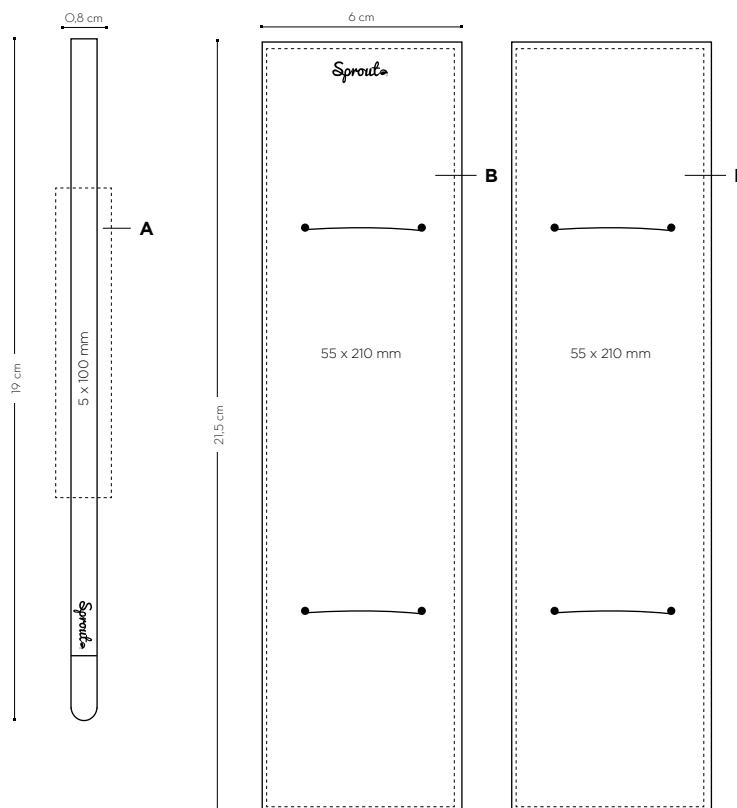

SPROUT™

Writing modes:

Mode écriture / Modos de escritura / Schreibmodi / Modalità di scrittura

Pencil



PC
HB Ø2,3mm

Printing techniques:

Techniques d'impression / Técnicas de impresión / Drucktechniken / Tecniche di stampa



(DG) DIGITAL



(LE) LASER

External packaging:

Emballage externe / Envasado exterior / Außenverpackung / Imballaggio esterno



500 ± 2,5 Kg Only pencil
± 5 Kg with cardboard packaging

Check out the video

Regardez la video / Mira el video / Produktvideo / Guarda il video





BIC® COLOURING

Set of 6 colouring pens with bright colours supported by the recognised BIC® brands: PLASTIDECOR®, EVOLUTION® and VISA®. Presented in a fully customized carton wallet, this is an ideal promotional item for children and teenagers!

FR > Set de 6 crayons aux couleurs vives sous les célèbres marques BIC® : PLASTIDECOR®, EVOLUTION® et VISA®. Présenté dans une pochette carton totalement personnalisée. Un article de promotion idéal pour les enfants et les ados !

DE > Set aus 6 Buntstiften mit leuchtenden Farben der bekannten BIC®-Marken: PLASTIDECOR®, EVOLUTION® und VISA®. Präsentiert in einem ganz den Kundenwünschen angepassten Etui aus Karton. Ein idealer Werbeartikel für Kinder und Jugendliche!

ES > Set de 6 lápices con colore brillantes bajo el soporte de las reconocidas marcas BIC®: PLASTIDECOR®, EVOLUTION® y VISA®. Presentado en una funda de carton totalmente personalizable, ésta es una idea de producto promocional tanto para niños como adolescentes!

IT > Set di 6 pastelli in vivaci colori con i famosissimi marchi BIC®: PLASTIDECOR®, EVOLUTION® e VISA®. Presentato in un astuccio di cartone personalizzato, è l'articolo promozionale ideale per bambini e teenager!



BIC® PLASTIDECOR® Set of 6 crayons



COLOURING CRAYONS 1201



100%

MOQ 500u.

Decoration:

Personnalisation / Personalización / Dekoration / Decorazione

BIC® PLASTIDECOR® Set of 6 crayons 1201

A DG: 4-colour process

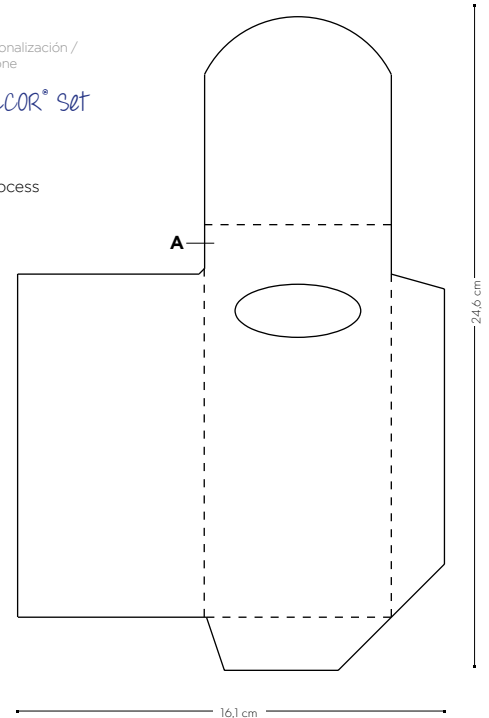

COLOURING PENS
BIC® WRITING INSTRUMENTS

Price (CHF)

BIC® PLASTIDECOR® Set of 6 crayons 1201	500-444	1000-2444	2500-4444	5000-4444	10000-24444	25000-44444
DG	3,65	2,75	2,25	1,97	①	①

All BIC® Colouring pens include 4-colour process printing on the carton wallet. Toute la gamme BIC® Colouring inclut l'impression en quadrichromie sur la pochette en carton. Toda la gama de BIC® Colouring incluye impresión en cuatricromía en el funda de cartón. Bei allen BIC® Colouring Malstiften ist Vierfarbdruck auf dem Kartonnetui inbegriffen. Tutti i pennarelli per colorare BIC® comprendono il processo di stampa a 4 colori sulla custodia in cartone.

① Price under request. Prix sur demande. Precio bajo consulta. Preis auf Anfrage. Prezzi su richiesta.

Writing modes:

Mode écriture / Modos de escritura / Schreibmodi / Modalità di scrittura



Packaging:

embalage / envasado / verpackung / imballaggio



01

Printing techniques:

Techniques d'impression / Técnicas de impresión / Drucktechniken / Tecniche di stampa



(DG) DIGITAL

External packaging:

Emballage externe / Envasado exterior / Außenverpackung / Imballaggio esterno



84 ± 3,8 Kg



MADE IN FRANCE

BIC® Visa® set of 6 felt pens



*Except black ink
*Sauf l'encre noire

FELT PENS 1203



MOA 500V.

Decoration:

Personnalisation / Personalización /
Dekoration / Decorazione

BIC® VISA® set of 6 felt pens
1203

A DG: 4-colour process

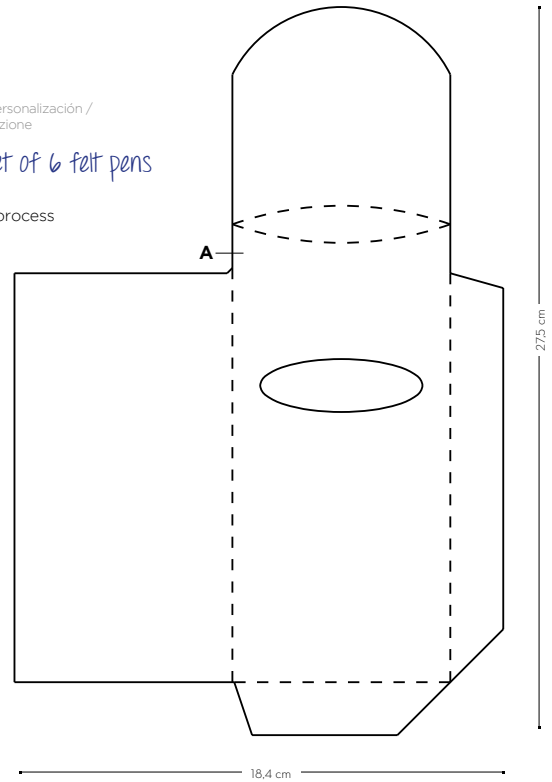

Price (CHF)

BIC® VISA® set of 6 felt pens	500-499	1000-2499	2500-4999	5000-9999	10000-24999	25000-49999
1203						
DG	5.20	4.22	3.71	3.29	①	①

All BIC® Colouring pens include 4-colour process printing on the carton wallet. Toute la gamme BIC® Colouring inclut l'impression en quadrichromie sur la pochette en carton. Toda la gama de BIC® Colouring incluye impresión en cuatricromía en el funda de cartón. Bei allen BIC® Colouring Malstiften ist Vierfarbdruck auf dem Kartonetui inbegriffen. Tutti i pennarelli per colorare BIC® comprendono il processo di stampa a 4 colori sulla custodia in cartone.

① Price under request. Prix sur demande. Precio bajo consulta. Preis auf Anfrage. Prezzi su richiesta.

BIC® WRITING INSTRUMENTS
COLOURING PENS

Writing modes:

Mode écriture / Modos de escritura /
Schreibmodi / Modalità di scrittura



Packaging:

emballage / envasado /
verpackung / imballaggio



01

Printing techniques:

Techniques d'impression / Técnicas de impresión /
Drucktechniken / Tecniche di stampa



(DG) DIGITAL

External packaging:

Emballage externe / Envasado exterior /
Außenverpackung / Imballaggio esterno



60 ± 2,4 Kg



MADE IN FRANCE



Set of 6 colouring pencils

COLOURING PENCILS 1202



*Made with 50% recycled material.

80%

easy to sharpen!

- FR > facile à affûter !
- ES > ¡Fácil de afilar!
- DE > Leicht anzuspitzen!
- IT > Facile da temperare!

MOQ 500v.

Decoration:

Personnalisation / Personalización / Dekoration / Decorazione

BIC® Evolution® Ecollections®
Set of 6 colouring pencils
1202

A DG: 4-colour process

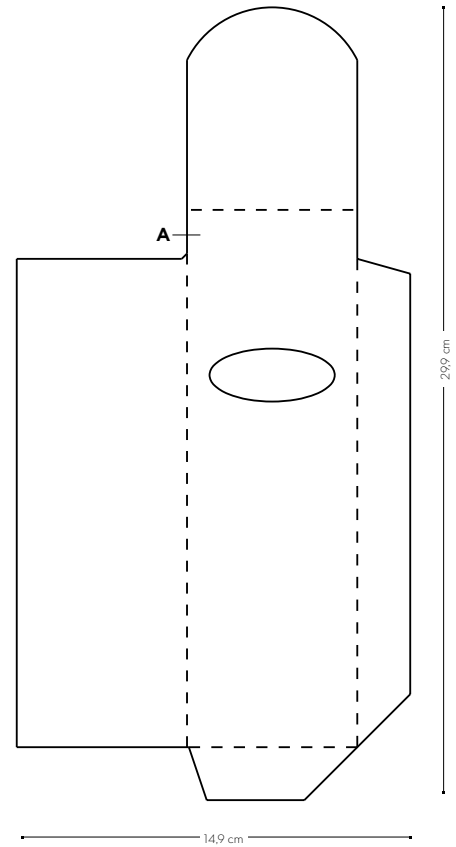

COLOURING PENS
BIC® WRITING INSTRUMENTS

Price (CHF)

BIC® evolution® ecollections® Set of 6 colouring pencils 1202	500-4999	1000-24999	2500-49999	5000-99999	10000-249999	25000-499999
DG	3.83	2.89	2.37	2.07	①	①

All BIC® Colouring pens include 4-colour process printing on the carton wallet. Toute la gamme BIC® Colouring inclut l'impression en quadrichromie sur la pochette en carton. Toda la gama de BIC® Colouring incluye impresión en cuatricromía en el funda de cartón. Bei allen BIC® Colouring Malstiften ist Vierfarbdruck auf dem Kartonetui inbegriffen. Tutti i pennarelli per colorare BIC® comprendono il processo di stampa a 4 colori sulla custodia in cartone.

① Price under request. Prix sur demande. Precio bajo consulta. Preis auf Anfrage. Prezzi su richiesta.

Writing modes:

Mode écriture / Modos de escritura / Schreibmodi / Modalità di scrittura



Packaging:

emballage / envasado / verpackung / imballaggio



C019520

01

Printing techniques:

Techniques d'impression / Técnicas de impresión / Drucktechniken / Tecniche di stampa



(DG) DIGITAL

External packaging:

Emballage externe / Envasado exterior / Außenverpackung / Imballaggio esterno



60 ± 2,6 Kg



MADE IN FRANCE



Set of 6 colouring pencils

Did you know?

Conté brand was founded more than 220 years back and is named after its founder, Nicolas - Jacques Conté. Born in France in 1755, he is considered as the inventor of "modern" pencil lead.

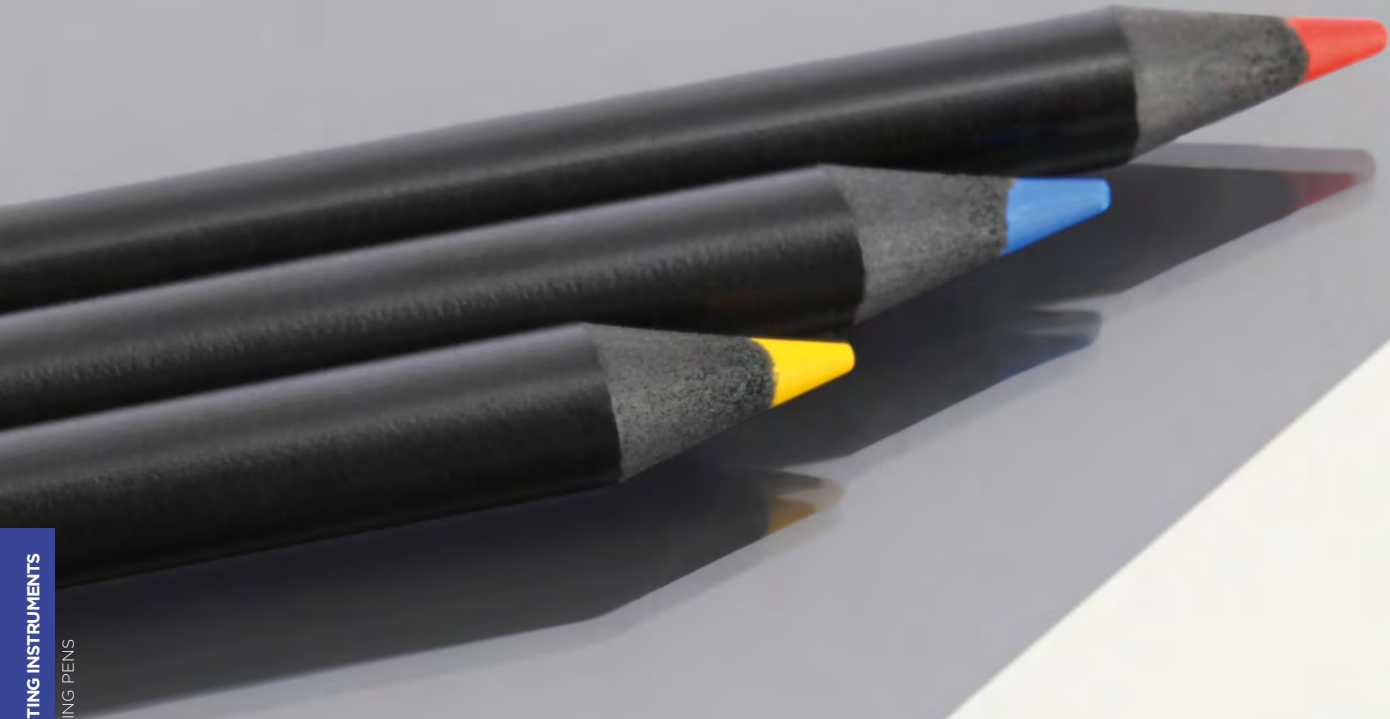

FR > Saviez-vous que ?
Conté® en tant que marque a été créée il y a plus de 220 ans et porte le nom de son fondateur, Nicolas-Jacques Conté. Né en France en 1755, il est considéré comme l'inventeur de la mine "moderne" du crayon à papier.

DE > Wussten Sie,
dass Conté vor mehr als 220 Jahren gegründet und nach dem Gründer, Nicolas-Jacques Conté, benannt wurde?
Er wurde 1755 in Frankreich geboren und gilt als der Erfinder der "modernen" Bleistiftmine.

ES > ¿Sabias que? La marca Conté se fundó hace más de 220 años y lleva el nombre de su fundador Nicolas - Jaques Conté. Nacido en Francia en 1755, es considerado como el inventor de la "pluma moderna"

IT > Lo sapevi?
Il marchio Conté è stato fondato più di 220 anni fa e prende il nome dal suo fondatore, Nicolas - Jacques Conté. Nato in Francia nel 1755, è considerato l'inventore della mina per matita "moderna".



Set of 6 colouring pencils



Strong lead



Vibrant Colours



COLOURING PENCILS 1178

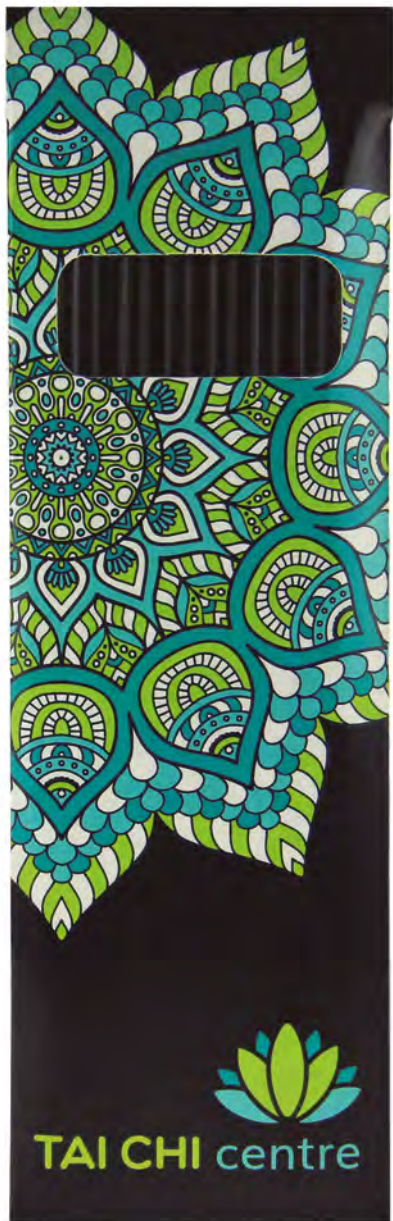

MOQ 500v.

Decoration:

Personalisation / Personalización /
Dekoration / Decorazione

Conté® set of 6 colouring pencils
1178

A DG: 4-colour process



wood free pencils

FR > crayons sans bois

ES > Lápices libres de madera

DE > Holzfreie Buntstifte

IT > matite senza legno

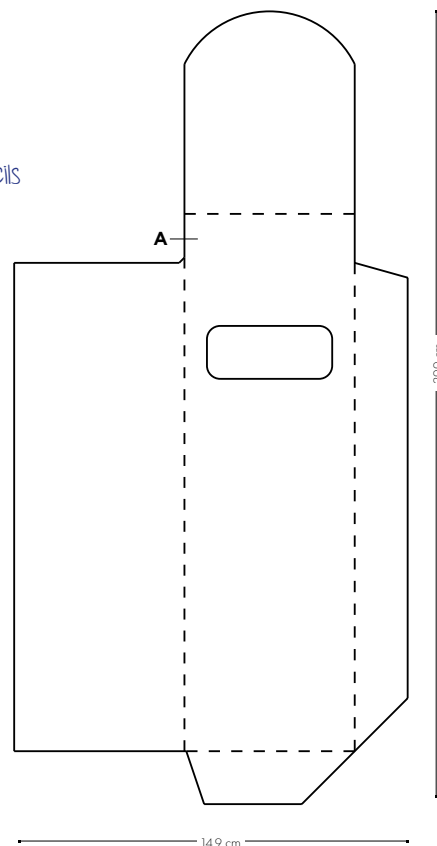

Price (CHF)

Conté® Set of 6 colouring pencils 1178	500-4999	1000-24999	2500-49999	50000-99999	100000-249999	250000-499999
DG	4,26	3,30	2,83	2,43	①	①

All BIC® Colouring pens include 4-colour process printing on the carton wallet. Toute la gamme BIC® Colouring inclut l'impression en quadrichromie sur la pochette en carton. Toda la gama de BIC® Colouring incluye impresión en cuatricromía en el funda de cartón. Bei allen BIC® Colouring Malstiften ist Vierfarbdruck auf dem Kartonetui inbegriffen. Tutti i pennarelli per colorare BIC® comprendono il processo di stampa a 4 colori sulla custodia in cartone.

① Price under request. Prix sur demande. Precio bajo consulta. Preis auf Anfrage. Prezzi su richiesta.

Writing modes:

Mode d'écriture / Modos de escritura /
Schreibmodi / Modalità di scrittura



Packaging:

embalage / envasado /
verpackung / imballaggio



Printing techniques:

Techniques d'impression / Técnicas de impresión /
Drucktechniken / Tecniche di stampa



(DG) DIGITAL

External packaging:

Emballage externe / Envasado exterior /
Außenverpackung / Imballaggio esterno



60 ± 2,2 Kg



MADE IN
FRANCE

COLOURING PENS
BIC® WRITING INSTRUMENTS





Colouring set

Create your fully customized colouring set: your favourite colouring set of pencils, a colouring book for kids or adults, and a nice cotton drawstring bag with BIC® logo.

FR > Créez votre set de coloriage totalement personnalisé : vos crayons de couleur favoris, un cahier de coloriage pour les enfants et les adultes, et un sac en coton à cordon coulissant, orné du logo BIC®.

ES > Crea tu set de colores totalmente personalizado: tu set de lápices de colores favoritos, un libro para colorear para niños o para adultos y una bonita bolsa con cordones con el logo BIC®.

DE > Kreieren Sie Ihr ganz individuelles Mal-Set: Ihr Lieblingssatz Buntstifte, ein Malbuch für Kinder oder Erwachsene und ein schöner Zugbeutel aus Baumwolle mit BIC®-Logo.

IT > Crea il tuo set per colorare completamente personalizzato: i tuoi pastelli preferiti, un libro da colorare per bambini o adulti e una bellissima borsa in cotone con chiusura a cordoncino e logo BIC® impresso.



COLOURING PENS
BIC® WRITING INSTRUMENTS



Colouring set

Create your own combination

 **PLASTIDÉCOR**® Set of 6 crayons,  **Visa**® Set of 6 felt pens or  **EVOLUTION**® **ecolutions**® Set of 6 colouring pencils

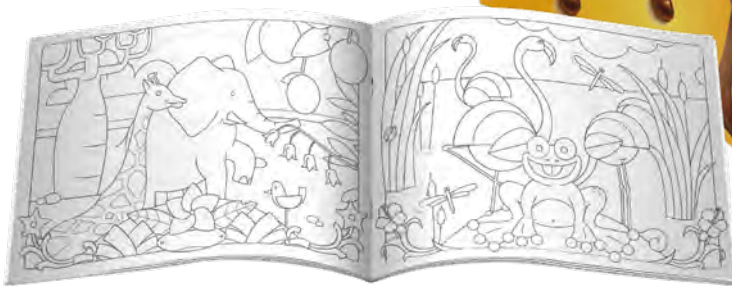

35%

Writing modes:

Mode écriture / Modos de escritura / Schreibmodi / Modalità di scrittura



Packaging:

emballage / emvasado / verpackung / imballaggio

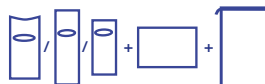

Printing techniques:

Techniques d'impression / Técnicas de impresión / Drucktechniken / Tecniche di stampa



(SP) SCREEN PRINTING



(OT) OFFSET TRANSFER

MOQ 500v.

Decoration:

Personalisation / Personalización / Dekoration / Decorazione

BIC® PLASTIDECOR®
colouring set
1294



BOX

C DG: 4-colour process

Bag

No imprint (bag)

A SP (bag): max 2 col.

B OT (bag): full-colour

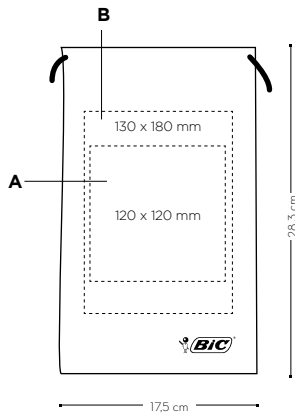

Book

C DG: 4-colour process

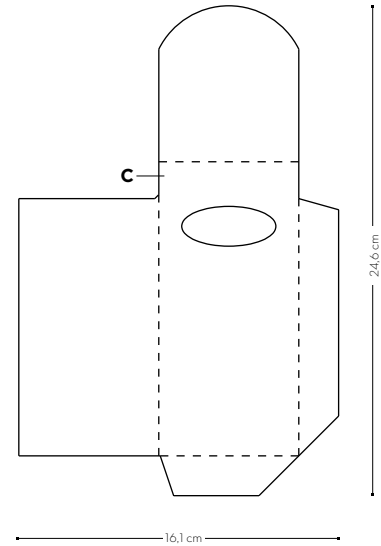
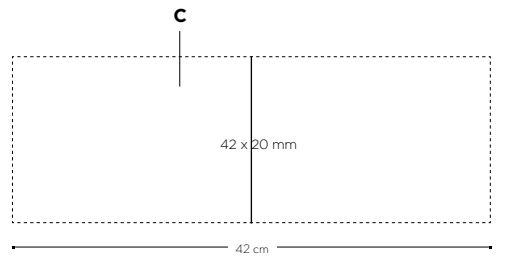

Price (CHF)

BIC® PLASTIDECOR®
colouring set 1294

	500-999	1000-2499	2500-4999	5000-9999	10000-24999	25000-49999
No imprint (bag)	11.29	8.13	6.50	5.45	①	①
SP (bag)	12.29	8.96	7.26	6.20	①	①
OT (bag)	13.36	9.99	8.28	7.22	①	①

ADDITIONAL IMPRINT CHARGE PER COLOUR & POSITION frais d'impression supplémentaires par couleur et position / cargo por impresión adicional por color y posición / zusätzliche druckkosten pro farbe & position / costo marchio aggiuntivo per colore e posizione

SP	1.00	0.83	0.76	0.75	①	①
OT	2.07	1.86	1.78	1.77	①	①

BIC® Colouring Pens sets are composed of a carton wallet, a coloring book and a cotton drawstring bag with BIC® logo. Prices include full colour personalisation on the carton box and the coloring book. Imprint on the bag is optional. Prices above vary according to the personalisation technique chosen for the bag. Les sets de coloriage BIC® Colouring sont composés d'une boîte à crayons de couleur, d'un cahier de coloriage et d'un sac en coton à cordon coulissant portant le logo BIC®. Le prix inclut la personnalisation complète de la boîte à crayons et du cahier de coloriage. L'impression sur le sac est en option. Les prix ci-dessus varient en fonction de la technique de personnalisation choisie pour le sac / El set de colores BIC® está compuesto de una funda de cartón, un libro para colorear y una bolsa con cordones con el logo BIC®. Los precios incluyen personalización a todo color en la funda de cartón y en el libro para colorear. La impresión de la bolsa es opcional. Los precios de arriba varían acorde de la técnica de personalización escogida para la bolsa / BIC® Colouring-Malstiftsets bestehen aus einem Kartonetui, einem Malbuch und einem Zugbeutel aus Baumwolle mit BIC®-Logo. In den Preisen inbegriffen ist Vierfarbdruck-Personalisierung auf Karton und Malbuch. Aufdruck auf dem Beutel auf Wunsch. Die oben angegebenen Preise können je nach für den Beutel gewählter Personalisierungstechnik variieren / I set di penne per colorare BIC® comprendono una custodia in cartone, un quaderno per colorare e una borsa in cotone con chiusura a cordoncino e logo BIC® impresso. I prezzi includono la personalizzazione a colori sulla scatola di cartone e sul quaderno per colorare. La stampa sulla borsa è opzionale. I suddetti prezzi possono variare in base alla tecnica di personalizzazione scelta per la borsa.

① Price under request. Prix sur demande. Precio bajo consulta. Preis auf Anfrage. Prezzi su richiesta.

External packaging:

Emballage externe / Envasado exterior / Außenverpackung / Imballaggio esterno



100 ± 10.8 Kg



Colouring set

BIC® VISA®
colouring set
1291



BOX
C DG: 4-colour process

Bag
No imprint (bag)
A SP (bag): max 2 col.
B OT (bag): full-colour

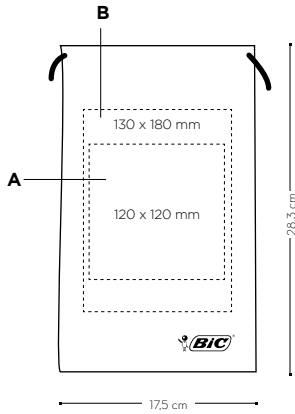

Book
C DG: 4-colour process

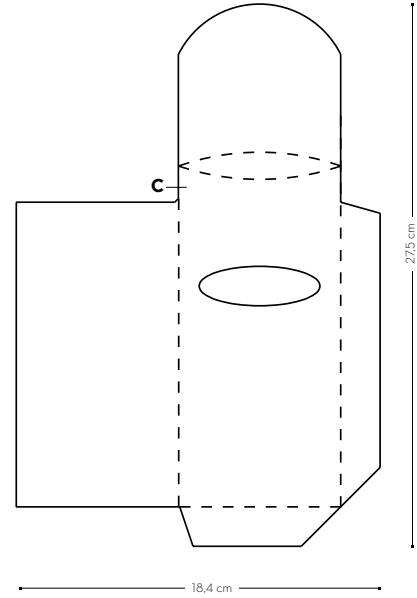
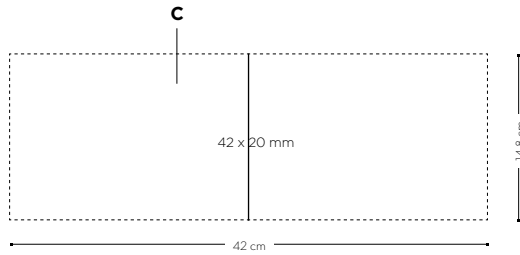

BIC® WRITING INSTRUMENTS
COLOURING PENS

	Price (CHF)					
BIC® VISA® colouring set 1291	500-499	1000-2499	2500-4999	5000-9999	10000-24999	25000-49999
No imprint (bag)	12,85	9,60	7,96	6,77	①	①
SP (bag)	13,85	10,43	8,72	7,52	①	①
OT (bag)	14,92	11,47	9,74	8,54	①	①

BAG: ADDITIONAL IMPRINT CHARGE PER COLOUR & POSITION frais d'impression supplémentaires par couleur et position / cargo por impresión adicional por color y posición / zusätzliche druckkosten pro farbe & position / costo marchio aggiuntivo per colore e posizione

SP	1,00	0,83	0,76	0,75	①	①
OT	2,07	1,86	1,78	1,77	①	①

BIC® Colouring Pens sets are made up of a personalised box, a coloring book and a cotton drawstring bag with BIC® logo. Prices include full colour personalisation on the box and the coloring book. Imprint on the bag is optional. Prices above vary according to the personalisation technique chosen for the bag. Les sets de coloriage BIC® Colouring sont composés d'une boîte de crayons de couleur, d'un cahier de coloriage et d'un sac en coton à cordon coulissant portant le logo BIC®. Le prix inclut la personnalisation complète de la boîte à crayons et du cahier de coloriage. L'impression sur le sac est en option. Les prix ci-dessus varient en fonction de la technique de personnalisation choisie pour le sac / Los sets BIC® Colouring Pens están compuestos por una caja personalizada, un libro para colorear y una bolsa de algodón con el logo BIC®, Los precios incluyen la personalización a todo color en la caja y en el libro para colorear. La impresión en la bolsa es opcional. Los precios anteriores varían según la técnica de personalización elegida para la bolsa / BIC® Mal-Sets bestehen aus einer Schachtel, einem Malbuch und einem Kordelzugbeutel aus Baumwolle mit BIC®-Logo. Die Preise beinhalten einen Digitaldruck auf der Schachtel und auf dem Malbuch. Aufdruck auf dem Beutel nach Wunsch. Die oben angegebenen Preise können je nach für den Beutel gewählter Personalisierungstechnik variieren / I set di penne per colorare BIC® comprendono una custodia personalizzata, un quaderno per colorare e una borsa in cotone con chiusura a cordoncino e logo BIC® impresso. I prezzi comprendono la personalizzazione a colori sulla scatola e sul quaderno per colorare. La stampa sulla borsa è opzionale. I suddetti prezzi possono variare in base alla tecnica di personalizzazione scelta per la borsa.

① Price under request. Prix sur demande. Precio bajo consulta. Preis auf Anfrage. Prezzi su richiesta.

External packaging:

Emballage externe / Envasado exterior / Außenverpackung / Imballaggio esterno



100 ± 10 Kg



BIC® evolution®
Ecolutions®
colouring set
1293



BOX
C DG: 4-colour process

Bag

No imprint (bag)
A SP (bag): max 2 col.
B OT (bag): full-colour

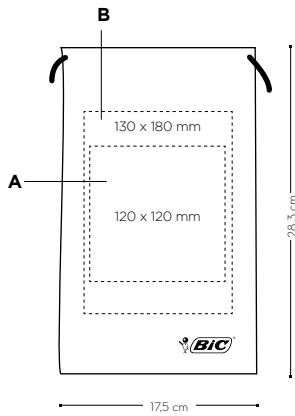

Book

C DG: 4-colour process

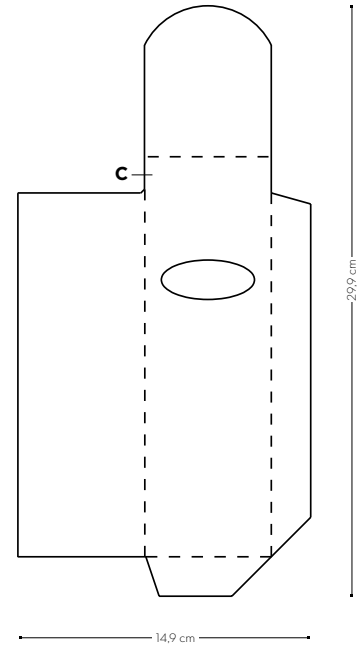
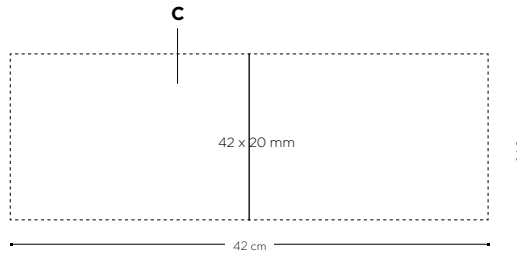

Price (CHF)

BIC® evolution® ecolutions®
colouring set 1293

	500-4441	1000-2441	2500-4441	5000-4441	10000-2441	25000-4441
No imprint (bag)	11,48	8,27	6,61	5,55	①	①
SP (bag)	12,48	9,10	7,37	6,30	①	①
OT (bag)	13,55	10,13	8,40	7,33	①	①

BAG: ADDITIONAL IMPRINT CHARGE PER COLOUR & POSITION frais d'impression supplémentaires par couleur et position / cargo por impresión adicional por color y posición / zusätzliche druckkosten pro farbe & position / costo marchio aggiuntivo per colore e posizione

SP	1,00	0,83	0,76	0,75	①	①
OT	2,07	1,86	1,78	1,77	①	①

BIC® Colouring Pens sets are made up of a personalised box, a coloring book and a cotton drawstring bag with BIC® logo. Prices include full colour personalisation on the box and the coloring book. Imprint on the bag is optional. Prices above vary according to the personalisation technique chosen for the bag. Les sets de coloriage BIC® Colouring sont composés d'une boîte de crayons de couleur, d'un cahier de coloriage et d'un sac en coton à cordon coulissant portant le logo BIC®. Le prix inclut la personnalisation complète de la boîte à crayons et du cahier de coloriage. L'impression sur le sac est en option. Les prix ci-dessus varient en fonction de la technique de personnalisation choisie pour le sac / Los sets BIC® Colouring Pens están compuestos por una caja personalizada, un libro para colorear y una bolsa de algodón con el logo BIC®. Los precios incluyen la personalización a todo color en la caja y en el libro para colorear. La impresión en la bolsa es opcional. Los precios anteriores varían según la técnica de personalización elegida para la bolsa / BIC® Mal-Sets bestehen aus einer Schachtel, einem Malbuch und einem Kordelzugbeutel aus Baumwolle mit BIC®-Logo. Die Preise beinhalten einen Digitaldruck auf der Schachtel und auf dem Malbuch. Aufdruck auf dem Beutel nach Wunsch. Die oben angegebenen Preise können je nach für den Beutel gewählter Personalisierungstechnik variieren / I set di penne per colorare BIC® comprendono una custodia personalizzata, un quaderno per colorare e una borsa in cotone con chiusura a cordoncino e logo BIC® impresso. I prezzi comprendono la personalizzazione a colori sulla scatola e sul quaderno per colorare. La stampa sulla borsa è opzionale. I suddetti prezzi possono variare in base alla tecnica di personalizzazione scelta per la borsa.

① Price under request. Prix sur demande. Precio bajo consulta. Preis auf Anfrage. Prezzi su richiesta.

External packaging:

Emballage externe / Envasado exterior /
Außenverpackung / Imballaggio esterno



100 ± 10,6 Kg





by  colouring set



BIC® WRITING INSTRUMENTS

COLOURING PENS



Writing modes:

Mode écriture / Modos de escritura / Schreibmodi / Modalità di scrittura



Printing techniques:

Techniques d'impression / Técnicas de impresión / Drucktechniken / Tecniche di stampa



(SP) SCREEN PRINTING



(OT) OFFSET TRANSFER

External packaging:

Emballage externe / Envasado exterior / Außenverpackung / Imballaggio esterno



100 ± 10,5 Kg



MOQ 500v.

Decoration:

Personalisation / Personalización /
Dekoration / Decorazione

Conté® by BIC® colouring set
1292



Box

C DG: 4-colour process

Bag

No imprint (bag)

A SP (bag): max 2 col.

B OT (bag): full-colour

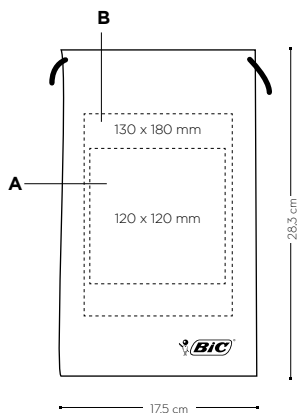

Book

C DG: 4-colour process

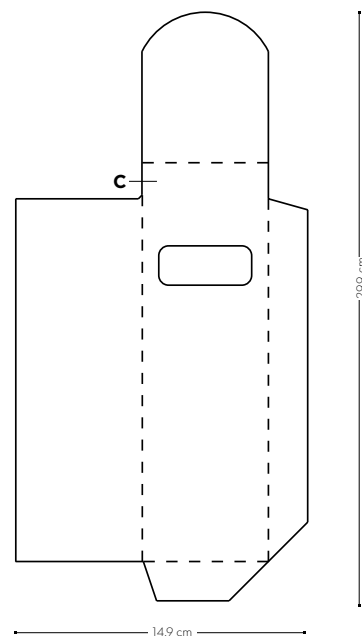
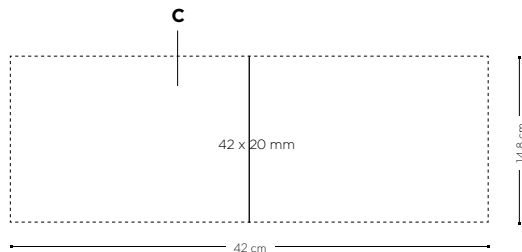

COLOURING PENS
BIC® WRITING INSTRUMENTS

Price (CHF)

Conté® by BIC® colouring set 1292	500-499	1000-2499	2500-4999	5000-9999	10000-24999	25000-49999
No imprint (bag)	11,90	8,68	7,07	5,91	①	①
SP (bag)	12,90	9,51	7,83	6,66	①	①
OT (bag)	13,97	10,55	8,86	7,68	①	①

BAG: ADDITIONAL IMPRINT CHARGE PER COLOUR & POSITION frais d'impression supplémentaires par couleur et position / cargo por impresión adicional por color y posición / zusätzliche druckkosten pro farbe & position / costo marchio aggiuntivo per colore e posizione

SP	1,00	0,83	0,76	0,75	①	①
OT	2,07	1,86	1,78	1,77	①	①

BIC® Colouring Pens sets are made up of a personalised box, a coloring book and a cotton drawstring bag with BIC® logo. Prices include full colour personalisation on the box and the coloring book. Imprint on the bag is optional. Prices above vary according to the personalisation technique chosen for the bag. Les sets de coloriage BIC® Colouring sont composés d'une boîte de crayons de couleur, d'un cahier de coloriage et d'un sac en coton à cordon coulissant portant le logo BIC®. Le prix inclut la personnalisation complète de la boîte à crayons et du cahier de coloriage. L'impression sur le sac est en option. Les prix ci-dessus varient en fonction de la technique de personnalisation choisie pour le sac / Los sets BIC® Colouring Pens están compuestos por una caja personalizada, un libro para colorear y una bolsa de algodón con el logo BIC®. Los precios incluyen la personalización a todo color en la caja y en el libro para colorear. La impresión en la bolsa es opcional. Los precios anteriores varían según la técnica de personalización elegida para la bolsa / BIC® Mal-Sets bestehen aus einer Schachtel, einem Malbuch und einem Kordelzugbeutel aus Baumwolle mit BIC®-Logo. Die Preise beinhalten einen Digitaldruck auf der Schachtel und auf dem Malbuch. Aufdruck auf dem Beutel nach Wunsch. Die oben angegebenen Preise können je nach für den Beutel gewählter Personalisierungstechnik variieren / I set di penne per colorare BIC® comprendono una custodia personalizzata, un quaderno per colorare e una borsa in cotone con chiusura a cordoncino e logo BIC® impresso. I prezzi comprendono la personalizzazione a colori sulla scatola e sul quaderno per colorare. La stampa sulla borsa è opzionale. I suddetti prezzi possono variare in base alla tecnica di personalizzazione scelta per la borsa.

① Price under request. Prix sur demande. Precio bajo consulta. Preis auf Anfrage. Prezzi su richiesta.



Tipp-Ex® Mini Pocket Mouse britePix™

The worldwide recognised correction tape Tipp-Ex® in its compact size, that provides an accurate application for both left and right-handed users with literally no dry time!

FR > Les BIC® Sticky Notes : le matériel de bureau indispensable. Faites votre choix parmi une multitude de tailles et de formes. Version Ecolutions® également disponible.

ES > Las BIC® Sticky Notes son una herramienta indispensable en cualquier oficina. Elige entre gran variedad de tamaños y formas. También disponibles en versión Ecolutions®.

DE > Die Haftnotizen BIC® Sticky Notes sind in jedem Büro unverzichtbar. Wählen Sie aus einer großen Auswahl Größen und Formen. Version Ecolutions® ebenfalls erhältlich

IT > BIC® Sticky Notes è uno strumento indispensabile in qualsiasi ufficio. Scegli tra una vasta gamma di dimensioni e forme. Disponibile anche in versione Ecolutions®



1354



MOA 250v.

Decoration:

Personnalisation / Personalización / Dekoration / Decorazione

Mini Pocket Mouse

1354

A BP: full-colour

BP Texture: full-colour

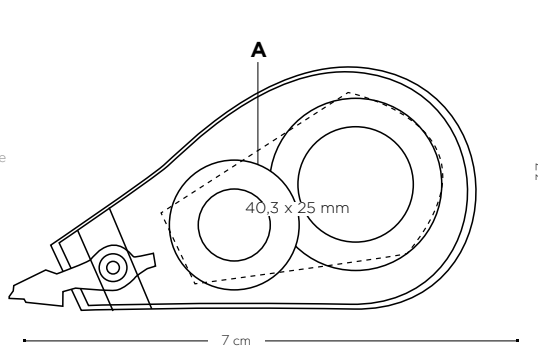

Price (CHF)

Tipp-Ex* Mini Pocket Mouse	250-499	500-999	1000-2499	2500-4999	5000-9999	10000-24999	25000-99999
1354							
BP	2,14	2,02	1,91	1,81	1,69	①	①
ADDITIONAL CHARGES: coûts supplémentaires: / cargos adicionales: / aufpreise: / costi aggiuntivi:							
BP	0,81	0,74	0,68	0,64	0,62	①	①
BP Texture	0,61	0,55	0,51	0,48	0,47	①	①

Prices include one imprint in one position according to specified technique. Les prix incluent une impression sur un emplacement avec la technique spécifiée / Los precios incluyen una impresión en una posición acorde con la técnica especificada / In den Preisen inbegriffen ist ein Aufdruck auf einer Position gemäß angegebener Technik / I prezzi includono una stampa in una posizione a seconda della tecnica specificata.

① Price under request. Prix sur demande. Precio bajo consulta. Preis auf Anfrage. Prezzi su richiesta.

Writing modes:

Mode écriture / Modos de escritura / Schreibmodi / Modalità di scrittura



T
6m

Printing techniques:

Techniques d'impression / Técnicas de impresión / Drucktechniken / Tecniche di stampa



(BP) britePix™



External packaging:

Emballage externe / Envasado exterior / Außenverpackung / Imballaggio esterno



288 ± 3,2 Kg

Check out the video

Regardez la vidéo / Mira el vídeo / Produktvideo / Guarda il video



*Source: GFK panel - Western Europe 9 - MAT June 2018 - Sales in Value & Volume



Other Writing Instruments

BIC® has approved these other writing instruments according to the quality and safety standards.

FR > BIC® a approuvé ces autres instruments d'écriture conformément aux normes de qualité et de sécurité.

ES > BIC® ha aprobado otros instrumentos de escritura acorde con los estándares de calidad y la seguridad.

DE > BIC® hat weitere Schreibgeräte gemäß den Qualitäts- und Sicherheitsstandards genehmigt.

IT > BIC® ha approvato questi altri strumenti di scrittura in base agli standard di qualità e sicurezza.



PLASTIC PENS
OTHER WRITING INSTRUMENTS



Basic pen

12010

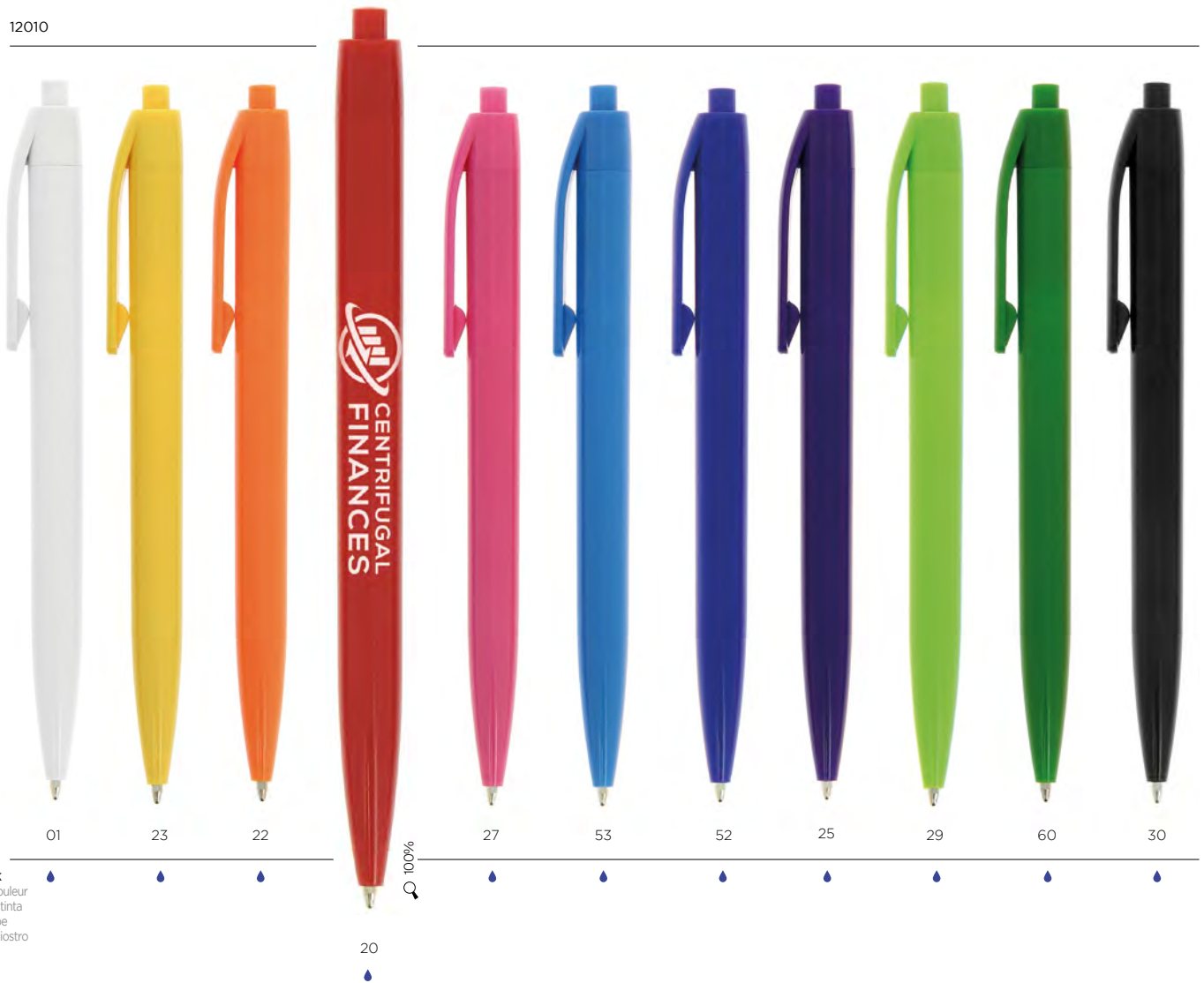

MOA 500v.

Decoration:

Personnalisation / Personalización /
 Dekoration / Decorazione

Basic pen
 12010

A/B SP: max. 1 col.

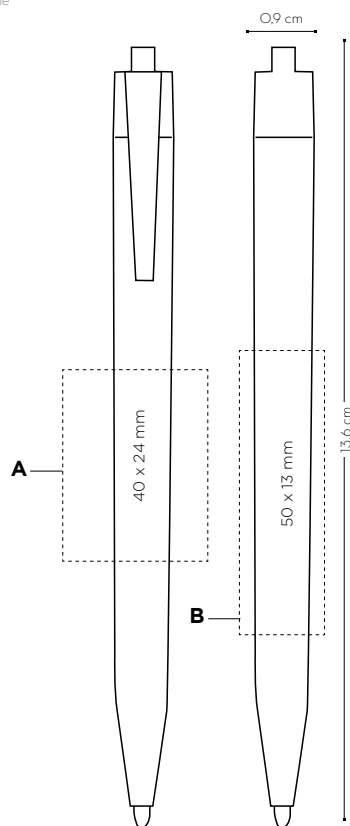

	Price (CHF)					
Basic pen	500-441	1000-2441	2500-4441	5000-4441	10000-24441	25000-44441
12010						
SP	0,54	0,43	0,36	0,32	①	①

Prices include 1 colour screenprint in one position. Les prix incluent la sérigraphie 1 couleur sur un emplacement. En precio incluye un color en serigrafía en una posición. In den Preisen inbegriffen ist 1 Siebdruck-Farbaufdruck auf 1 Position. I prezzi includono 1 colore a serigrafia in una posizione.

① Price under request. Prix sur demande. Precio bajo consulta. Preis auf Anfrage. Prezzi su richiesta.

Writing modes:

Mode écriture / Modos de escritura /
 Schreibmodi / Modalità di scrittura

Ballpen



M

Printing techniques:

Techniques d'impression / Técnicas de impresión /
 Drucktechniken / Tecniche di stampa



(SP) SCREEN
 PRINTING

External packaging:

Emballage externe / Envasado exterior /
 Außenverpackung / Imballaggio esterno



1000 ± 12,5 Kg



Click pen

11748

OTHER WRITING INSTRUMENTS

PLASTIC PENS



Colour ink
 Encre de couleur
 Color de la tinta
 Schreibfarbe
 Colore inchiostro

White stock lasts Jusqu'à épuisement de stock / Hasta fin de existencias / Solange Vorrat reicht / Fino a esaurimento scorte



MOQ 500v.

Decoration:

Personnalisation / Personalización /
 Dekoration / Decorazione

Click pen

11748

A/B SP: max. 4 col.

C/D PD: max. 4 col.

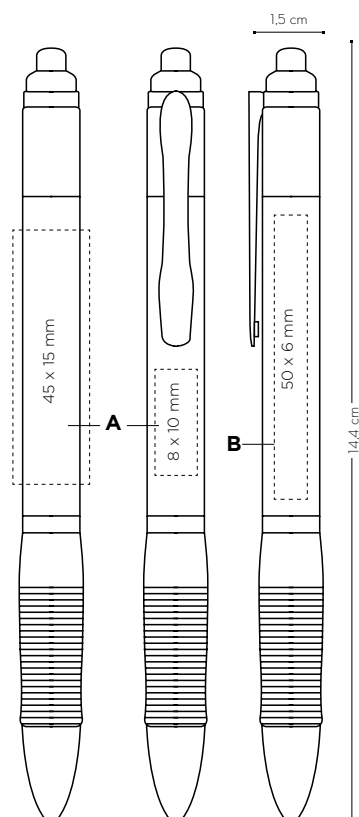

Price (CHF)

Click pen	500-499	1000-2499	2500-4999	5000-9999	10000-24999	25000-49999
11748						
SP	0,59	0,47	0,40	0,37	①	①
PD	0,67	0,56	0,48	0,45	①	①

ADDITIONAL CHARGES: coûts supplémentaires: / cargos adicionales: / aufpreise: / costi aggiuntivi:

SP	0,15	0,15	0,15	0,14	①	①
PD	0,38	0,29	0,21	0,20	①	①

Prices include one imprint in one position according to specified technique. Les prix incluent une impression sur un emplacement avec la technique spécifiée / Los precios incluyen una impresión en una posición acorde con la técnica especificada / In den Preisen inbegriffen ist ein Aufdruck auf einer Position gemäß angegebener Technik / I prezzi includono una stampa in una posizione a seconda della tecnica specificata.

① Price under request. Prix sur demande. Precio bajo consulta. Preis auf Anfrage. Prezzi su richiesta.

Writing modes:

Mode écriture / Modos de escritura /
 Schreibmodi / Modalità di scrittura

Ballpen



M

Printing techniques:

Techniques d'impression / Técnicas de impresión /
 Drucktechniken / Tecniche di stampa



(SP) SCREEN
 PRINTING



(PD) PAD
 PRINTING

External packaging:

Emballage externe / Envasado exterior /
 Außenverpackung / Imballaggio esterno



1000 ± 9,5 Kg



Striped Grip pen

11243



22

20

27

25

51

50

100%

29

60

Colour ink
Encre de couleur
Color de la tinta
Schreibfarbe
Colore inchiostro

OTHER WRITING INSTRUMENTS

PLASTIC PENS



MOA 500v.

Decoration:

Personalisation / Personalización /
 Dekoration / Decorazione

Striped Grip pen

11243

A SP: max. 2 col.

B PD: max. 1 col.

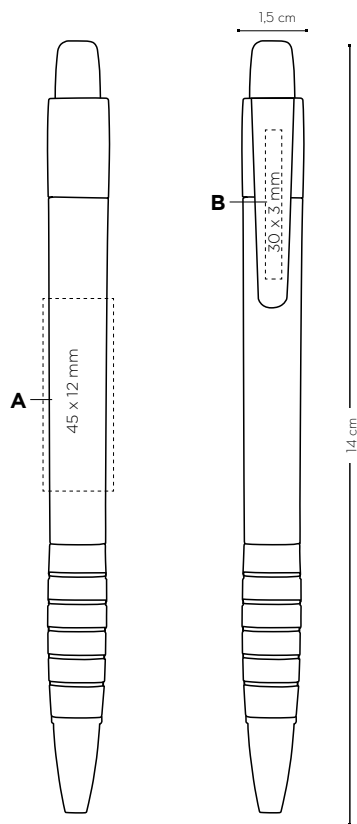

Price (CHF)

Striped Grip pen	500-999	1000-2499	2500-4999	5000-9999	10000-24999	25000-49999
11243						
SP	0,70	0,59	0,52	0,47	①	①
PD	0,78	0,68	0,60	0,55	①	①

ADDITIONAL CHARGES: coûts supplémentaires: / cargos adicionales: / aufpreise: / costi aggiuntivi:

SP	0,15	0,15	0,15	0,14	①	①
PD	0,38	0,29	0,21	0,20	①	①

Prices include 1 colour screenprint in one position. Les prix incluent la sérigraphie 1 couleur sur un emplacement. En precio incluye un color en serigrafía en una posición. In den Preisen inbegriffen ist 1 Siebdruck-Farbaufdruck auf 1 Position. I prezzi includono 1 colore a serigrafia in una posizione.

① Price under request. Prix sur demande. Precio bajo consulta. Preis auf Anfrage. Prezzi su richiesta.

Writing modes:

Mode écriture / Modos de escritura /
 Schreibmodi / Modalità di scrittura

Ballpen



M

Printing techniques:

Techniques d'impression / Técnicas de impresión /
 Drucktechniken / Tecniche di stampa



(SP) SCREEN
 PRINTING



(PD) PAD
 PRINTING

External packaging:

Emballage externe / Envasado exterior /
 Außenverpackung / Imballaggio esterno



1000 ± 9 Kg



White striped Grip pen

OTHER WRITING INSTRUMENTS

PLASTIC PENS

11303



20



27



50



25



29



30

Colour ink
Encre de couleur
Color de la tinta
Schreibfarbe
Colore inchiostro

100%



MOQ 500v.

Decoration:

Personnalisation / Personalización /
 Dekoration / Decorazione

White striped Grip pen

11303

A SP: max. 2 col.

B PD: max. 1 col.

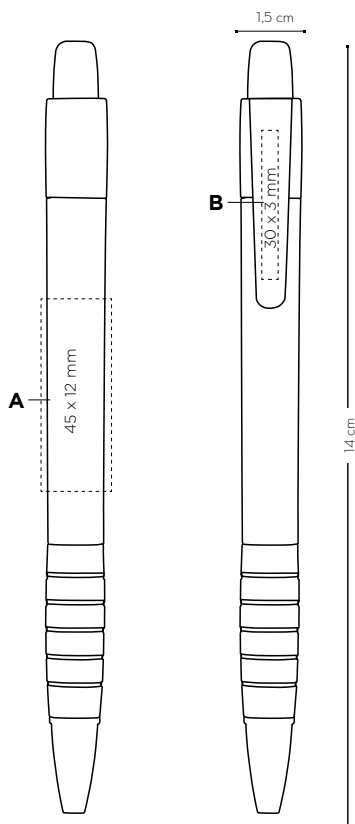

Price (CHF)

White striped Grip pen	500-999	1000-2499	2500-4999	5000-9999	10000-24999	25000-49999
11303						
SP	0,70	0,59	0,52	0,47	①	①
PD	0,78	0,68	0,60	0,55	①	①

ADDITIONAL CHARGES: coûts supplémentaires: / cargos adicionales: / aufpreise: / costi aggiuntivi:

SP	0,15	0,15	0,15	0,14	①	①
PD	0,38	0,29	0,21	0,20	①	①

Prices include 1 colour screenprint in one position. Les prix incluent la sérigraphie 1 couleur sur un emplacement. En precio incluye un color en serigrafía en una posición. In den Preisen inbegriffen ist 1 Siebdruck-Farbaufdruck auf 1 Position. I prezzi includono 1 colore a serigrafia in una posizione.

① Price under request. Prix sur demande. Precio bajo consulta. Preis auf Anfrage. Prezzi su richiesta.

Writing modes:

Mode écriture / Modos de escritura /
 Schreibmodi / Modalità di scrittura

Ballpen



M

Printing techniques:

Techniques d'impression / Técnicas de impresión /
 Drucktechniken / Tecniche di stampa



(SP) SCREEN
 PRINTING



(PD) PAD
 PRINTING

External packaging:

Emballage externe / Envasado exterior /
 Außenverpackung / Imballaggio esterno



1000 ± 9 Kg



Sleek stylus pen

Sleek stylus pen

11666



Colour ink
Encre de couleur
Color de la tinta
Schreibfarbe
Colore inchiostro

Sleek stylus Matt pen

11747



Sleek stylus Executive pen

11976



OTHER WRITING INSTRUMENTS

STYLUS - PENS



MOQ 100v. (LE)
 MOQ 500v. (SP)

Decoration:

Personnalisation / Personalización /
 Dekoration / Decorazione

Sleek stylus pen
 11666

Sleek stylus matt pen
 11747

Sleek stylus executive pen
 11976

A SP: max. 1 col.

B SP: max. 2 col.

C/D/E/F LE

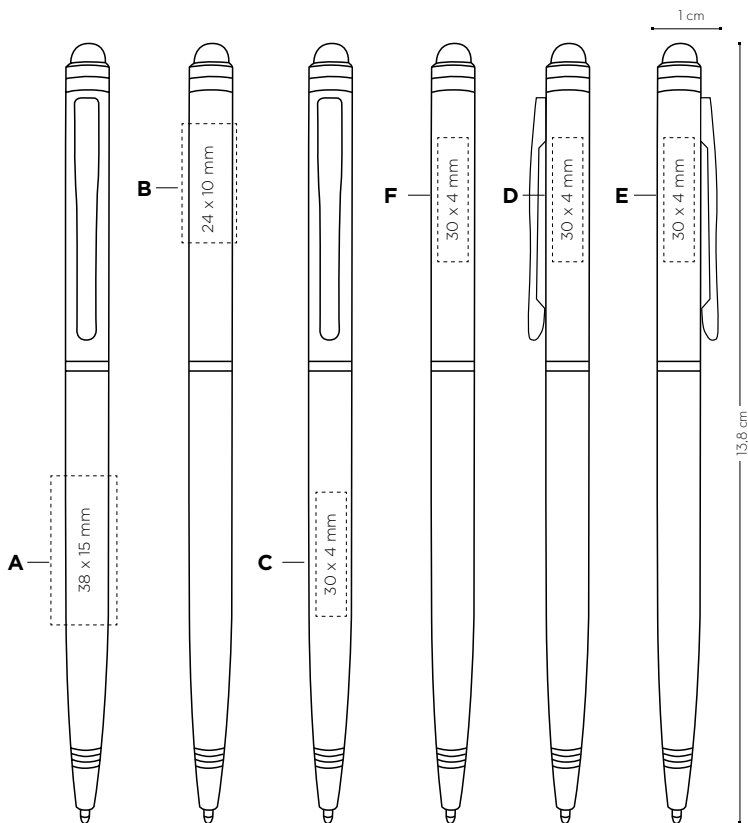

	Price (CHF)						
	100-249	300-499	500-999	1000-2499	2500-4999	5000-9999	10000-24999
Sleek stylus pen							
11666							
SP	-	2,52	2,31	2,13	2,06	①	①
LE	3,90	3,30	3,02	2,85	2,82	①	①
11747							
SP	-	2,65	2,43	2,23	2,16	①	①
LE	4,03	3,43	3,14	2,96	2,92	①	①
11976							
SP	-	2,67	2,45	2,25	2,19	①	①
LE	4,05	3,45	3,16	2,98	2,94	①	①

ADDITIONAL CHARGES: coûts supplémentaires: / cargos adicionales: / aufpreise: / costi aggiuntivi:

SP	-	0,40	0,35	0,24	0,24	①	①
LE	1,99	1,47	1,27	1,16	1,13	①	①

Prices include 1 colour screenprint in one position. Les prix incluent la sérigraphie 1 couleur sur un emplacement. En precio incluye un color en serigrafía en una posición. In den Preisen inbegriffen ist 1 Siebdruck-Farbaufdruck auf 1 Position. I prezzi includono 1 colore a serigrafia in una posizione.

① Price under request. Prix sur demande. Precio bajo consulta. Preis auf Anfrage. Prezzi su richiesta.

Writing modes:

Mode écriture / Modos de escritura /
 Schreibmodi / Modalità di scrittura

Ballpen



M

Printing techniques:

Techniques d'impression / Técnicas de impresión /
 Drucktechniken / Tecniche di stampa



(SP) SCREEN
 PRINTING



(LE) LASER

External packaging:

Emballage externe / Envasado exterior /
 Außenverpackung / Imballaggio esterno



11666

900 ± 12,4 Kg



11747
 11976

800 ± 13 Kg

Laser engraving not available in yellow/silver colour
 Gravure laser non disponible en couleur jaune / argent - Grabado láser no disponible en color amarillo y plata - Lasergravur
 nicht auf Kugelschreiber in gelb und silber erhältlich - Incisione laser non disponibile per il colore giallo/argento